

USE & MAINTENANCE INSTRUCTIONS

EN SAFETY CABINETS FOR FLAMMABLES

90 MINUTE SERIES



**BUREAU
VERITAS**

eu.justrite.com

For use & maintenance instructions in other languages see back page.

ESSENTIAL INDUSTRIAL SAFETY PRODUCTS

At Justrite, we partner with customers to better understand, anticipate and systematically address the safety challenges you face every day. Our extensive portfolio allows us to think holistically about your organization's vulnerabilities and deliver enterprise-wide compliance.

Justrite products and expertise help your organization to:

- Reduce fire risks
- Prevent environmental contamination
- Provide emergency relief to injured personnel
- Avoid injuries & accidents
- Avoid fines associated with non-compliance
- Stay in compliance to changing regulations
- Fulfill insurance carrier recommendations
- Improve housekeeping & operational efficiencies



Customized to Your Requirements

We offer custom spill berms, safety cabinets and HPLC safety cans. Custom colours for certain products are also available. Whatever the requirement or special need, Justrite safety experts will design and manufacture a solution that meets and exceeds your unique needs.

Free, Consultative Safety Survey

Our free, consultative STUD-E™ surveys address the inherent concerns with handling volatile hazardous liquids. STUD-E surveys are available in comprehensive formats for Storage, Transfer, Use, Disposal and Evaluation of hazardous materials.

The surveys are designed to help you meet

OSHA and EPA regulations, and are backed by over a century's worth of safety experience. Put Justrite expertise to work for you to improve your overall safety program.

Providing Global Protection

Justrite safety products are available worldwide. For pricing and availability, simply contact an authorized distributor near you or visit our website at eu.justrite.com.

For Justrite Authorized Distributors Customer Access Network (CAN)—24/7 Support Sign-up today at www.buyjustrite.eu.

CONTENTS

1	GENERAL INFORMATION	6	5	USE	17
1.1	Contents and scope of the manual	6	5.1	Usable spaces and gaps	17
1.2	Ownership of the information	6	5.2	Commissioning	17
1.3	Conventions	6	5.3	Storage	17
1.3.1	Terminological conventions	6	5.3.1	Storage capacity	18
1.3.2	Typographical conventions	6	5.4	Decanting	18
1.4	Manufacturer data	6	5.5	Tray shelves and collection tray	18
1.5	Cabinet identification data	6	5.6	Door closing	19
1.6	Assistance	6	5.6.1	Safety cabinet version EN Safety Cabinets 90 minutes	19
1.7	Liability	6	5.6.2	Door lock	20
2	SAFETY	7	5.7	Opening the cabinet after a fire	20
2.1	Introduction	7	6	MAINTENANCE	21
2.1.1	Storage of chemical products	7	6.1	Inspections and Maintenance Register	21
2.1.2	Protecting containers and their arrangement	7	6.2	Routine maintenance	21
2.2	General warnings	8	6.2.1	Daily and monthly checks to be carried out autonomously	21
2.3	Prohibitions	9	6.3	Extraordinary maintenance	21
2.4	Personal protective equipment (PPE)	9	7	DECOMMISSIONING	22
3	DESCRIPTION	10	7.1	After normal use	22
3.1	Fire-resistant safety cabinet	10	7.2	After a fire	22
3.2	Main features	10	8	DEACTIVATION AND DISPOSAL	22
3.3	Structure	10	8.1	Deactivation	22
3.4	Intended use	11	8.1.1	Precautions for storage	22
3.5	Non-intended use	11	8.2	Disposal	23
3.6	Operating principle	11	8.3	Information to users	23
4	INSTALLATION	12	9	TROUBLESHOOTING	23
4.1	Reception of the product	12			
4.2	Technical characteristics	12			
4.3	Transport	13			
4.3.1	Transport conditions	13			
4.3.2	Inspection of damage caused during transport	13			
4.4	Storage	13			
4.5	Arrangements to be made by the customer	14			
4.6	Handling	14			
4.6.1	Packaged cabinet	14			
4.6.2	Unpacked and assembled cabinet	14			
4.7	Installation site	15			
4.8	Location	16			
4.9	Internal equipment	17			
4.9.1	Collection tray on the bottom	17			
4.9.2	Tray shelves	17			

Dear Valued Customer,

We would like to thank you for choosing Justrite® for your EN safety cabinet for flammables.

Our EN safety cabinets allow the safe storage of flammable substances in the workplace. Justrite's EN cabinets offer top performance for indoor flammable liquid storage and protection.

This user manual contains important information on use and maintenance as well as suggestions which must be observed for optimal use of the **EN safety cabinets for flammables**.

Thank you for choosing Justrite.



Justrite is a portfolio company of Justrite Safety Group.

For over a century, Justrite Safety Group has helped protect where the world works. Our mission is to identify workplace vulnerabilities and guide customers in creating an ecosystem of safety—so your team can work with confidence.

Start with the EssentialSM

The essence of our company is captured in a new tagline: Start with the EssentialSM.

At Justrite, everything starts with safety. Protecting people, property and the planet is our first and greatest responsibility. We provide the essential safety products you need to protect your workers and workplace.

To learn more about our full portfolio of products, please visit eu.justrite.com.

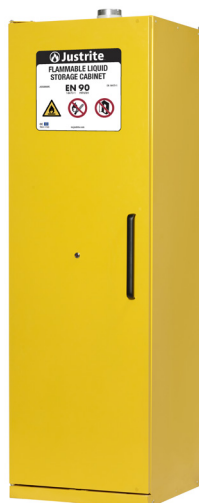

BEFORE SIGNING THE TRANSPORT DOCUMENT (ALSO SPECIFIED ON THE PACKAGING), YOU MUST IMMEDIATELY CHECK THE “TILTWATCH ALERT” WHICH IS ATTACHED TO THE OUTSIDE OF THE PACKAGING.

IF THE INDICATOR IS RED, IT MEANS THAT THE SAFETY CABINET WAS HANDLED IMPROPERLY DURING TRANSPORT.

IMMEDIATELY INFORM THE DRIVER AND THE SHIPPING COMPANY, THEN ADD “ACCEPTED UNDER RESERVE” ON THE TRANSPORT DOCUMENT, EXPLAINING THE REASONS WHY.

WARRANTY

The manufacturer’s warranty for cabinets used for storing dangerous substances lasts 36 months from the date of delivery.

These cabinets are classified as technological safety equipment and, as such, are subject, pursuant to the EN and DIN standards, to annual compulsory inspections by the authorised Technical Assistance Service or by people authorised by the Head of the Prevention and Protection Service (RSSP) on account of their background, experience, training and knowledge of the relevant regulations.

FAILURE TO CONDUCT THESE INSPECTIONS SHALL VOID THE WARRANTY.

REGULATORY REFERENCES AND CERTIFICATIONS

The performance standards of the safety cabinet for flammable products fall within the UNI EN 14470 European standard which defines the safety and performance requirements.

More specifically, the technical standard:

- UNI EN 14470-1:2004 (TYPE 90) – Part 1: safety storage cabinets for flammable liquids

All models of the safety cabinet specified in this instruction manual have been subjected to destructive testing in a furnace. The tests were conducted in an independent accredited laboratory.

Our **EN** safety cabinets are certified by the BUREAU VERITAS.

WRITE HERE THE SERIAL NUMBER OF THE SAFETY CABINET FOR FLAMMABLE PRODUCTS

1 GENERAL INFORMATION

1.1 Contents and scope of the manual



This manual describes the safety cabinet, its intended use and its technical characteristics.



The purpose of this manual is to provide essential information regarding use and maintenance of the safety cabinet, foster a sense of responsibility and inform the user of its capabilities and limits.



The persons deemed suitable for performing a specific task must possess the appropriate physical and mental abilities to understand the instructions imparted to them.



The instructions contained in this manual do not replace but supplement the obligations to be fulfilled with regard to the applicable safety and accident-prevention regulations.

1.2 Ownership of the information

This manual contains reserved-ownership information – all rights reserved.

This manual cannot be reproduced or photocopied, wholly or partly, without prior written permission from Justrite Safety Group EMEA B.V.

This documentation may only be used by the customer to which the manual has been supplied together with the safety cabinet and solely for the installation, use and maintenance of the product itself, to which this manual refers.

Justrite Safety Group EMEA B.V. hereby declares that the information provided in this manual is consistent with the technical and safety specifications of the safety cabinet to which the manual refers.

Justrite Safety Group EMEA B.V. declines all liabilities for direct or indirect damages to objects and harm to people or domestic animals deriving from the use of this documentation or of the safety cabinet in ways other than those intended.

Justrite Safety Group EMEA B.V. reserves the right to make changes or improvements to this documentation and to the safety cabinet, including any commercialised products of the same model referred to herein but having a different serial number.

The information contained in this manual refers, in particular, to the safety cabinet specified in “5.1 Usable spaces and gaps” on page 17.

1.3 Conventions

1.3.1 Terminological conventions

- Product, cabinet, safety cabinet:
Safety cabinet for flammable products.
- The descriptions of the orientation, direction and position (right or left of the cabinet) refer to the position of the operator facing the main control panel.
- Qualified personnel: persons who – due to their training, experience, background and knowledge of the relative rules, provisions and measures to for preventing accidents and of the service conditions:
 - have been authorised by the safety supervisor to carry out any necessary activity;
 - are able to recognise and prevent potential hazards.

1.3.2 Typographical conventions

PPE: personal protective equipment.

(3) or (B): symbolic representation of a control or signalling device (for example, buttons, selectors and indicator lights) or a part of the product.



WARNING/PLEASE NOTE = concerns important information that demands special attention.



DANGER : concerns actions that require special caution and adequate training.



FORBIDDEN = concerns actions that must rigorously NOT be carried out.

NOTE= they contain important information given outside of the text to which they refer.

1.4 Manufacturer data

Justrite Safety Group EMEA B.V.

Achterzeedijk 57, Barendrecht, 2992SB, The Netherlands
Tel: +31 (0) 180 615 744 - Fax: +31 (0) 180 611 551

E-mail: saleseu@justrite.com

1.5 Cabinet identification data

An identification plate is affixed to the product that shows the essential data and technical characteristics of the safety cabinet for flammable products.



The data appearing on the manufacturer's identification plate must always be mentioned when submitting requests for technical assistance and/or spare parts.

1.6 Assistance

For any queries or problems, the Justrite Safety Group EMEA B.V. authorised Technical Assistance Service will be on hand for technical support, training activities and maintenance operations.

1.7 Liability

Justrite Safety Group EMEA B.V. declines all liabilities for any harm to people or domestic animals and damage to objects deriving from failure to observe the safety rules and recommendations contained in the documentation provided.

2 SAFETY

 We recommend carefully reading the information given below and strictly observing the relevant instructions, in order to prevent potential inconveniences and accidents during the product's operation.

 This chapter does not replace but supplements the obligations to be fulfilled with regard to the applicable safety and accident-prevention regulations.

2.1 Introduction

The laboratory activities require prudent judgement and careful assessment of the attendant risks, but also the adoption of appropriate procedures for minimising the health and safety risks to which the people involved are exposed.

Four essential principles must be observed when carrying out laboratory activities:

- 1 Make a preliminary assessment.
Assessment of the potential danger associated with the analytical method before implementing it.
- 2 Minimise exposure to chemical agents.
Prevent chemical agents from coming into contact with the skin. Use, as far as possible, devices for minimising the duration and exposure to chemical agents. Always wear the designated personal protective equipment (PPE).
- 3 Do not underestimate the risks.
Assume that all the chemical substances or mixes are more dangerous than the individual chemical agents. Treat all substances for which the dangerousness is unknown and all specimens to be analysed as if they were potentially toxic.
- 4 Be ready in case of accidents.
Get acquainted with the actions to be carried out in case of accidents implicating hazardous substances. It is necessary to know the location of all safety systems, the nearest fire alarm system and the nearest telephone, to know what numbers to dial and what to say in case of an emergency, and to be prepared to adopt all the necessary first-aid measures.

2.1.1 Storage of chemical products

The mere presence in the laboratory of dangerous substances/mixtures constitutes a source of chemical risk; for this reason, it is necessary to adopt certain precautions for their storage that may require the use of a special safety cabinet.

Below we include a few general recommendations.







CARCINOGENIC AGENTS AND/OR MUTAGENS

Carcinogenic and/or mutagenic substances/mixtures classified under categories 1A and 1B according to the CLP Regulation must always be stored in a locked compartment and access to them must solely be granted to expressly authorised personnel.

MANAGEMENT OF REAGENTS



When managing chemical products it is necessary to keep the stored quantities under control, signal their hazardousness and arrange the actions to be implemented in the event of accidental leakage.

We therefore recommend observing the following indications:

-  Keep an updated register for every depot/cabinet showing the substances/mixtures present and the quantities stored.
-  Perform a periodic inspection (at least once a year) of the chemical products stored: those which cannot be identified, or are deteriorated or old, must be eliminated.
-  Reduce to a minimum the quantities of hazardous chemical products and replace, where possible, hazardous products with other non-hazardous or less hazardous ones.
-  Keep, for each substance/mixture present in the laboratory, an updated safety data sheet and observe any special indications appearing in the sheet itself (under the "Handling" and "Storage" sections).
-  Affix to each depot/cabinet the necessary warning signs (e.g. flammable materials) and prohibition signs (e.g. forbidding the use open flames) in a clearly visible position.
-  Make sure that all the containers are labelled so that their contents can be identified at all times.
-  Arrange emergency procedures to be implemented in the event of accidental dispersions of the product. In particular, arrange, near the cabinets containing liquid chemicals, materials for absorbing and neutralising any spills. Refer to the safety data sheets for information when choosing the most suitable materials.

2.1.2 Protecting containers and their arrangement

To reduce the possibility of accidentally breaking a container, we recommend taking the following precautions:

-  Avoid overloading the shelves (observe their maximum load-bearing capacity). See "5.5 Tray shelves and collection tray" on page 18).
-  Avoid amassing containers one on top of the other. Preferably place the larger containers and the ones containing the most hazardous substances/mixtures at the bottom.
-  Avoid placing containers on shelves that are too high up; arrange corrosive, caustic or irritant substances/mixtures at a height below eye-level.

 If there are no tray-type shelves, use shelves with a raised outer edge so as to prevent the containers from accidentally slipping.

 Make sure that the substances/mixtures are not placed near heat sources or under direct sunlight.

COMPATIBILITY AND CONTAINMENT

When storing the products, always consider the possibility that the containers may accidentally break; adopt the following precautions to limit the damages:

 Keep substances/mixtures that are chemically incompatible – that is, capable of reacting chemically – in separate compartments. This condition implies, for example, that acids be separated from bases and that combustible/flammable materials be separated from fuels (oxidants).

 Keep the containers with solid materials separate from containers with liquid materials. Solid materials are normally poorly reactive, but can considerably increase their reactivity when placed in contact with a liquid.

 Store liquid containers inside collection trays capable of containing their accidental spillage. Moreover, place a collection tray at the bottom of the cabinet.

2.2 General warnings

 The recommended approach is to replace dangerous substances with harmless or less dangerous alternatives (for example, an equivalent less dangerous reagent, use ready-made solutions available on the market without having to treat the pure substances).

 Carefully read in advance the safety data sheets (SDSs) of the chemical products you intend using. The SDSs must be available to the user.

 Carefully read in advance the labels attached to the containers, especially the pictograms, hazard indications (H) and prudence advice (P) appearing on them.

 Observe the laws and provisions relative to the handling of hazardous substances, as well as the notes contained in these instructions for use.

 Works on the electrical system must be made in the absence of electricity and by specialised electricians. In this regard, also consult the relevant accident-prevention regulations, the CEI, UNI and EN standards and the regulations of the local electricity provider.

 It is necessary to observe the customer's specific installation conditions (e.g. anchorage of the cabinets to the building).

 It is necessary to observe the instructions of the inspection/supervision Technical Service.

 Observe the relevant accident-prevention rules and the occupational regulation. Always wear appropriate personal protective equipment (PPE).

 Make sure that the necessary technical safety inspections are carried out exclusively by the authorised Technical Assistance Service or by specialised and duly authorised personnel, and that original spare parts are used.

 Use the cabinet only after receiving training; unauthorised people must be forbidden from accessing it.

 The door rotation area must always be kept clear and doors/drawers must be kept closed.

 Specialised trained/authorised personnel allows for preventing malfunctions, damages and deterioration caused by corrosion, ascribable to improper storage.

 Pay attention to the maximum limits relative to the storable quantities, stress, etc.

 It is forbidden to insert containers with a capacity exceeding the quantity that can be collected by the tray on the bottom. Spilled hazardous substances must be collected and removed immediately.

 It is necessary to ensure adequate technical ventilation.

 Before storing the products, verify whether the surfaces of the cabinet can withstand the chemical to be stored.

 Containers that contain aggressive chemicals (acids and bases) must be placed in cabinets with special drawers and shelves for acids and bases.

 Storing corrosive liquids can have repercussions on the efficiency of the devices for blocking the delivery and exhaust air.















 Prior to commissioning, the user must examine the safety cabinet to identify potential damages.

 Keep the laboratory clean and tidy.

 Always promptly report any unsafe conditions, accidents and dangerous situations to the person in charge.

 Access to fire extinguishers, escape routes, electrical cabinets and cabinets containing shut-off and adjustment valves for fluids (technical gases, water, etc.) must be unobstructed.

2.3 Prohibitions

-  Forbid unauthorised persons from accessing the risk zones.
-  Do not store unidentifiable materials.
-  Do not introduce any materials and objects not pertaining to the work activity.
-  Do not store or keep food or beverages inside the cabinet.
-  Do not smoke in the workplaces.
-  Do not work on your own in situations with particular risks (chemical agents, dangerous equipment or reactions, etc.).
-  Do not touch handles or other objects with the gloves used to handle the chemical agents.
-  It is forbidden to throw chemical substances or mixes down the washbasin or in paper waste bins. Solid and liquid waste contaminated with chemical agents must be disposed of according to the applicable laws and collected in appropriate containers arranged in the laboratory.
-  It is forbidden to mix waste items unless they are grouped according to similar EWC codes.
-  It is forbidden to mix hazardous and non-hazardous waste.
-  Do not install the safety cabinet in places with poor or inadequate ventilation. The safety cabinet is designed for being installed in an adequate location, such as laboratories and warehouses.
-  The safety cabinet must be installed, used and stored in a way that guarantees the safety of operators against potential fires or explosions.
-  It is forbidden to store substances that, due to their self-ignition properties or instability, can cause fires and explosions.
-  Substances with flash point below 100°C (for example, hydrogen sulphide) cannot be stored in the safety cabinet situated in work environments, unless the cabinet is ventilated and the substances are stored in appropriate containers.

2.4 Personal protective equipment (PPE)

-  Personal protective equipment (PPE) must be worn when it is not possible to prevent, reduce or adequately tackle the risks with technical prevention measures.

The protective equipment for personnel includes:

- safety glasses;
- gloves compatible with the substances handled and with the activities carried out:
 - for protection against chemical agents (even disposable);
 - for high temperatures;
 - for cryogenic liquids;
- long-sleeved lab coats with closures at the cuffs;
- moccasin-type safety footwear.



Specific activities or particularly hazardous substances may require additional or different PPE offering enhanced protection even when the operations are carried out with the aid of protective equipment.

This equipment may include, for example:

- protective visor;
- respirators or masks.

Moreover, in order to manage chemical emergency situations (spills, leakages, etc.), the following devices are present in the laboratories:

- specific protective overalls;
- full face masks;
- boots.

3 DESCRIPTION

 The user is responsible for assessing whether the safety cabinet is suited to the specific requirements.

 This type of safety cabinet cannot be used for protection against biological risks.

 The safety cabinet should be regarded as actual safety device as it must ensure the health of the operators working in the laboratory.

3.1 Fire-resistant safety cabinet

Flammable solids and liquids (acids and bases) must be stored in fire-resistant safety cabinets.

The standard classifies safety cabinets on the basis of the time required – under specific heating conditions – to raise their internal temperature by 180 K without potentially triggering or fuelling a fire.

The number identifying the type of cabinet gives an idea of how long the cabinet can resist if subjected to fire.

The choice of the type of cabinet must take into account the evacuation time of personnel and how long it takes the emergency teams to extinguish a fire.

TYPE	TIME REQUIRED TO RAISE THE TEMPERATURE BY 180 K
15	≥ 15 min
30	≥ 30 min
60	≥ 60 min
90	≥ 90 min

 The inclusion of a fire-resistant safety cabinet within a chemistry laboratory requires a TYPE 90 cabinet.

3.2 Main features

The standard requires that the cabinets, regardless of their type, satisfy a series of specifications.

The main ones are described below:

- Cabinets: they must be configured for ventilation. Forced aeration is advisable if there are containers that are not hermetically closed, especially if they contain volatile substances/mixtures; in this case, to reduce the odour, a ventilation of at least 10 changes of air is necessary (the load loss must not exceed 150 Pa). The ventilation system must keep the cabinet under negative pressure.
- Cabinet doors: they must be equipped with a device that closes the doors automatically when the ambient temperature reaches 50°C.

- Vent and exhausted air outlet: they must close automatically when the temperature reaches 70°C. The seals and valves in the vents must close automatically at this temperature. The seals are normally intumescent: if heated, they transform into a foam characterised by high insulating power.
- Height of the shelves: the height of the top shelf must not exceed 1.75 metres.
- Shelves: they must be tray-shaped so as to contain potential liquid spills caused by damages or accidental ruptures of the containers.
- Bottom tray: it must always be present to collect any liquid leakages that have not been completely withheld by the tray shelves. Its capacity must be at least 10% of the volume of all the containers stored in the cabinet or at least 110% of the volume of the largest container.
- Electrostatic discharges: the cabinets are equipped with an earthing system which must be connected to the electrical systems' earth, so as to prevent electrostatic discharges.

3.3 Structure

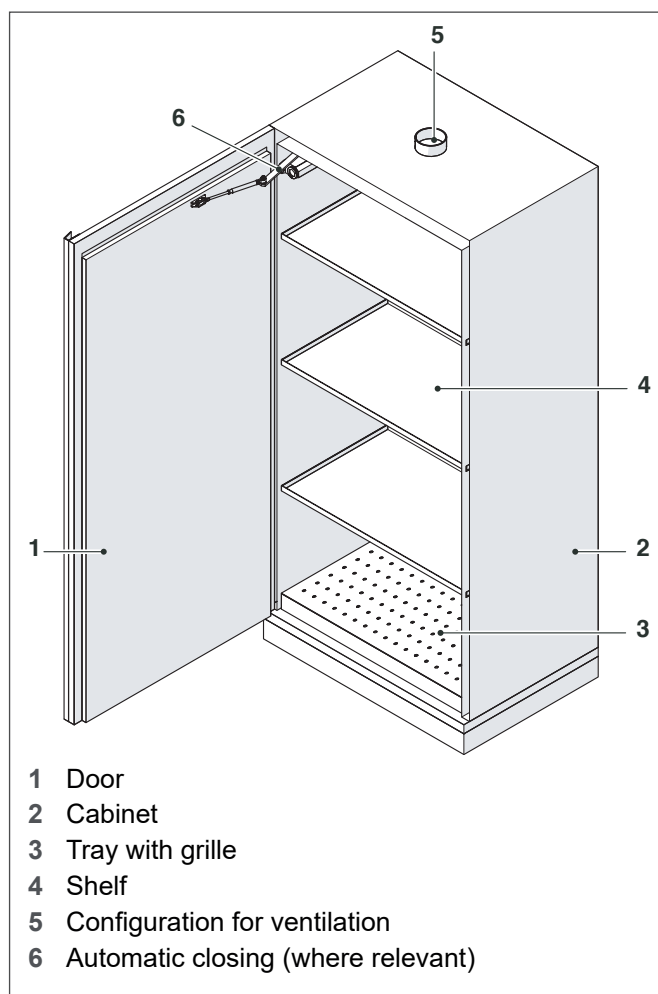

- 1 Door
- 2 Cabinet
- 3 Tray with grille
- 4 Shelf
- 5 Configuration for ventilation
- 6 Automatic closing (where relevant)

The Justrite Safety Group EMEA B.V. safety cabinet is built as follows:

- It is made entirely of electrogalvanised cold-pressed steel sheet with a thickness of 1–1.5 mm.
- The outer finish consists of epoxy resin capable of withstanding acids and the passage through a thermal tunnel at 200 °C.
- The cabinet is isolated by means of high-density rock wool panels and calcium sulphate panels.
- Inner finish consisting of melamine panels highly resistant to chemical and aggressive vapours.
- Intumescent 30 mm insulating seals which, in case of a temperature increase, guarantee a perfect seal of the cabinet.

3.4 Intended use

Storage and conservation of all high- or low-flammability materials.

3.5 Non-intended use

All uses not indicated under the INTENDED USE section.

3.6 Operating principle

The main purpose of a storage cabinet is the safe storage of hazardous substances (solid or liquid) in case of fire, for a specified duration.

The internal temperature of the cabinet during the specified time must not exceed 180 °C (50 °C in case of gases) to prevent explosions, allow personnel to escape and the fire-fighting and rescue teams to intervene.

PROTECTION AGAINST FIRE

- In case of fire, the cabinet must guarantee – for at least 15 minutes – that its contents do not aid fire propagation.

DOORS

- The cabinet doors must close fully, regardless of their current position (maximum closing time 20 seconds).
- The automatic closing devices (if present) must lock the doors if the 50 °C temperature is reached near the cabinet itself.
- The closing force of the doors must not exceed 100 N.
- It must be possible to operate them with one hand only and the doors must close completely even if they are of the lockable type.

SIDE AND REAR WALLS

- The side walls and the rear wall of the cabinet must have the same thickness and structure.

VENTILATION

- The cabinets must have openings to allow air to enter and escape and must be designed for being connected to an air extraction system.
- The vents must close automatically if subjected to a temperature of 70 ± 10 °C.
- The ventilation system must operate continuously in a permanent manner and vent outside, in a non-risky point.

- The cabinet's pressure drop must not exceed 150 Pa.
- For a ventilated cabinet, the air change must be:
 - equal to at least 10 times the cabinets' volume of air per hour (when flammable substances are used).

STORAGE SYSTEMS

- The surfaces used for storage purposes must be able to withstand the load specified by the manufacturer.

LEAKAGE CONTAINMENT BASIN

- The leakage containment basin must retain its operating capacity even after the fire resistance test. This can be inspected visually by filling the tray with water.

4 INSTALLATION

4.1 Reception of the product

BEFORE SIGNING THE TRANSPORT DOCUMENT (AS ALSO SPECIFIED ON THE PACKAGING), IMMEDIATELY VERIFY THE “TILTWATCH ALERT” AFFIXED TO THE OUTSIDE OF THE PACKAGING. IF THE INDICATOR IS RED, IT MEANS THAT THE SAFETY CABINET WAS HANDLED IMPROPERLY DURING TRANSPORT. IMMEDIATELY INFORM THE DRIVER AND THE SHIPPING COMPANY, THEN ADD “ACCEPTED UNDER RESERVE” ON THE TRANSPORT DOCUMENT, EXPLAINING THE REASONS THEREOF.

4.2 Technical characteristics

EN SAFETY CABINETS (TYPE 90) SERIES

DESCRIPTION	OUTER DIMENSIONS (INNER DIMENSIONS) (mm)	STORAGE CAPACITY*	WEIGHT (kg)
JCB22608YL	595 x 600 x 2070 (496 x 446 x 1540)	80 / 100	216
JCB22609YL	1200 x 600 x 2070 (1095 x 446 x 1540)	176 / 220	365
JCB22610YL	595 x 600 x 2070 (496 x 446 x 1540)	80 / 100	216

(*) Approximate capacity per cabinet with 1-litre bottles

4.3 Transport

The instructions contained in this section must be observed when transporting the safety cabinet, in other words during:

- storage
- initial installation
- relocation

Never drop / rest the cabinet vigorously as, being rather sturdy, it could get damaged and its sharp edges could ruin the floor surface.

PREVENTIVE INSPECTION OF THE SPACES RESERVED FOR TRANSPORT AND INSTALLATION

PLACE	DIMENSIONS	UOM	
LORRY	With characteristics capable of withstanding the weight of the cabinet		
TRANSIT	Minimum height	4	m
	Minimum width	3	m
RECEPTION	Inspect the reception zone (e.g. loading ramp, flat surface)		
DOORS	Minimum height	2.30	m
	Minimum load capacity	500	kg
GOODS LIFT	Minimum height (including doors)	2.30	m
	Minimum depth (in case of low doors)	2.30	m
	Minimum width	1.50	m
	Minimum width	1.50	m
STAIRS	Landing depth	2.20	m
	If beyond the first floor, use a goods lift		

4.3.1 Transport conditions

The cabinet must be handled with care and always kept in the vertical position during transport.

The safety cabinet is supplied already assembled, wrapped in thermoformed material and packed on a wooden pallet suitable for being raised with a forklift truck.

The cabinet must be transported with the aid of industrial transport means and/or vehicles, such as lorries, with a body sufficiently large for containing the cabinet.

It must be suitably anchored to the transport vehicle (for example using ropes).

During transport, it must be protected against rain, snow, hail, wind and any other potentially adverse weather conditions. To this aim, it is advisable to use closed-body transport vehicles (vans, curtain-side lorries, etc.) or to cover the vehicle with waterproof sheets.

4.3.2 Inspection of damage caused during transport

Verify the condition of the safety cabinet by means of a visual inspection.

The packaging also contains the “TILTWATCH ALERT”.

When the indicator turns red, it means that the cabinet fell or suffered a strong impact or swung excessively during transport or handling.

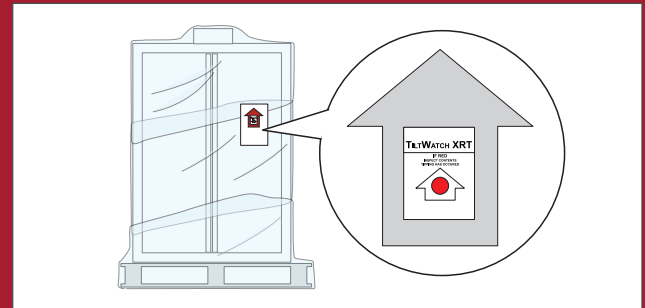

If the “TILTWATCH ALERT” is red, immediately inform the driver and the shipping company.

The product must be inspected to assess any damages. Moreover, remember to write the “reserve” on the transport document, justifying the reason. At any event, the standard procedures must be implemented when managing claims.

Transport-related damages must be ascribed to the shipping company and signalled.

4.4 Storage

The indications contained in this section must be observed during the temporary storage periods which may occur in the following situations:

- supply not immediately followed by the cabinet's installation;
- removal and storage of the cabinet pending its

relocation.

The safety cabinet must be stored and transported by implementing the following safety conditions:

- isolate it from power sources;
- remove dust and foreign bodies;
- cover it with plastic sheets;
- store it in a dry place protected against dust and contaminants.

Environmental conditions for storage

- allowed temperature: from 0 °C to 35 °C;
- allowed relative humidity: 30–70 % (without any condensate);
- adequate natural and/or artificial illumination;
- adequate protection against atmospheric agents;
- sufficient space reserved for performing lifting and transport operations in safe and easy conditions;
- horizontal support surface with load-bearing capacity higher than the mass of parts making up the safety cabinet.

 Do not climb or place any object on the safety cabinet.

4.5 Arrangements to be made by the customer

The following arrangements must be made by the customer:

- Illumination of the work zones (sufficient intensity and distribution, as envisaged in the regulations in force).
- Connections to the electricity network.

4.6 Handling

 Prior to starting handling operations, make sure that the handling and installation zones are free of obstacles and that there is enough space for moving the cabinet and its accessories safely.

 Check that the load-bearing capacity of the equipment used to handle the cabinet is adequate for lifting the load (see “4.2 Technical characteristics” on page 122).

 Prior to the lifting operations, make sure that nobody lies in the immediate vicinity of the work zone.

4.6.1 Packaged cabinet

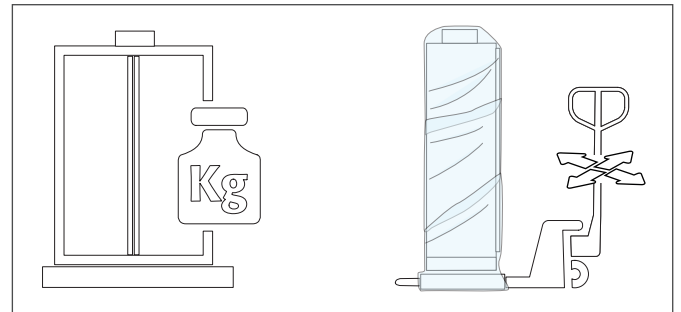



Use a pallet truck to move the cabinet, which must be placed vertically and be secured and protected against slipping up to its final installation site.

 Inappropriate handling can cause damages to the flame insulation device.

 It is forbidden to use equipment with loading widths exceeding the access widths.

 It is necessary to take into account the clear opening of the base when choosing the pallet truck.

 The protections for transport located at the joints of the doors must only be removed at the final installation site.

 We can only guarantee the necessary quality if the cabinet is carried up to its point of use by our specialised personnel who have been adequately trained.

4.6.2 Unpacked and assembled cabinet

Once its packaging has been removed, the cabinet can be handled manually. At least two specialised persons are required for handling.

 It is forbidden to disperse the packaging material into the environment or leave it within reach of children as it could be potentially dangerous. It must therefore be disposed of in accordance with the applicable laws.

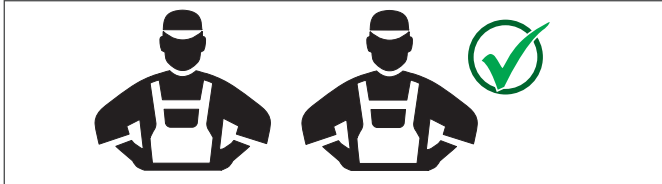

Handle the cabinet by letting it slide on the pallet.

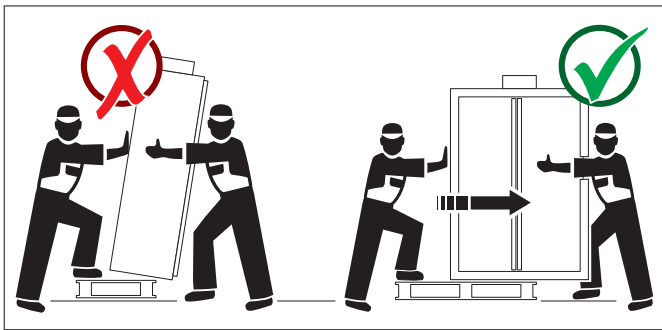

When the cabinet touches the ground, support it so that the pallet can be removed.

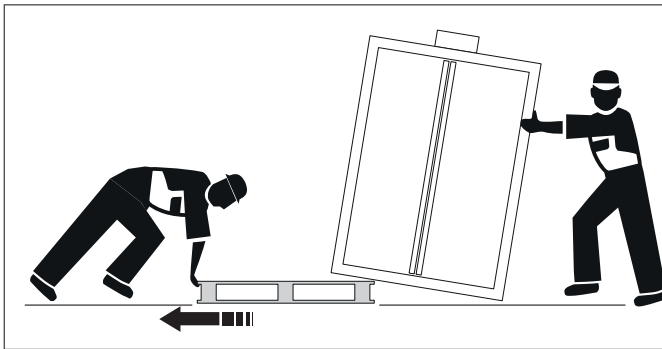

After removing the pallet, lower the cabinet slowly and without jolts to avoid damaging it.

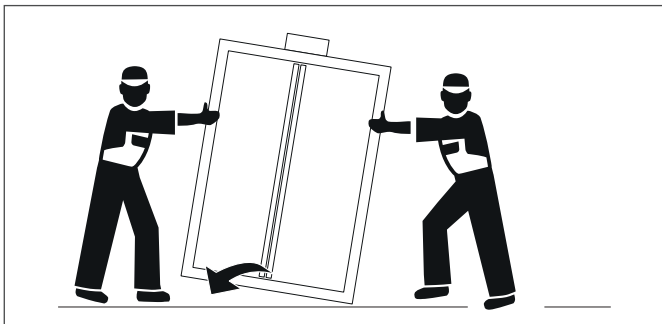

After installing the cabinet, remove the protections for transport present along the door joints.

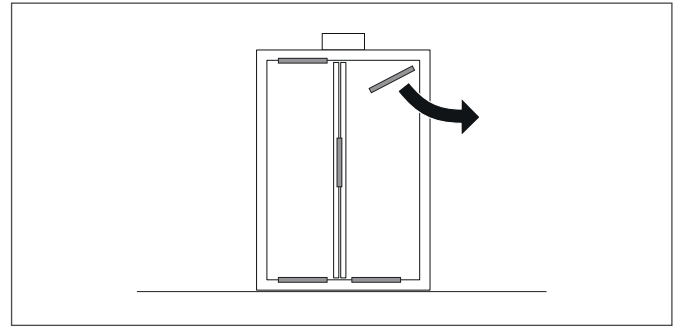

 Justrite Safety Group EMEA B.V. declines all responsibility for any harm to people and/or damages to property deriving from incorrect lifting of the cabinet carried out:

- by unauthorised or inadequately trained personnel;
- using with inadequate lifting equipment;
- without following the indications and operating procedures described in this manual.

4.7 Installation site

ZONE

The installation zone must have the following characteristics:

- The area around the cabinet must be free so that the doors can be opened and the user has enough space to operate;
- A well ventilated room (in particular for cabinets lacking a ventilation system);
- The work environment must not be subject to potential explosions and fire in case of vapours leaking from the burned liquids;
- It must not be near work stations where operations that can spark potential ignitions (e.g. Grinding or welding activities) are conducted;
- There must not be any risk of damages due to transiting vehicles;
- It must not be located outdoors and must nonetheless be protected against direct contact with atmospheric agents.

VENTILATION

 The fire-safety valves in the delivery and exhaust air fittings area are important components in terms of safety and maintenance. In order to verify the efficient operation of or replace a defective component, it is important to consider that flexible connecting pipes or sliding components are used when connecting the cabinet to an air expulsion system, so as to guarantee easy dismantling and reassembly of the exhaust air fitting.

With extraction system

Connect the extraction system to the fitting on the roof (100 mm diameter) to allow the air to escape.

The air always enters from the rear side.

The air inlet and outlet are equipped with safety valves that close by means of a thermal fuse at a temperature of $\geq 70\text{ }^{\circ}\text{C}$.

Without ventilation

The interior of the non-ventilated cabinet is regarded as a CLASS 1 sector subject to the risk of explosion. Comply with the provisions of the directives concerning protection against explosions, especially with regard to the prevention of electrostatic discharges.

Pursuant to the UNI EN 14470 standard, it can be used in work environments considering the area surrounding the safety cabinet as a CLASS 2 SECTOR SUBJECT TO THE RISK OF EXPLOSION, more specifically:

- The entire zone surrounding the cabinet for 2.5 metres and at least 0.5 metres above the floor, if there is no ventilation;
- The entire zone surrounding the cabinet for a distance of 1 metre in front of the cabinet, 0.5 metres to the sides and a height of 0.3 metres from the floor, when there is a technical ventilation system and a change of air at least 5 times greater.

If the cabinet is made to work without connecting the exhaust air, the user must affix a marking.

SUPPORT SURFACE

The support surface must have:

- A stable, solid, flat and non-flammable surface;
- Characteristics capable of withstanding the weight of the cabinet (see “4.2 Technical characteristics” on page 12) with a full load;
- Minimum $\pm 5\text{ mm/m}$ flatness.

ILLUMINATION

Proper illumination is necessary to ensure safe use of the cabinet.

The cabinet is not equipped with internal illumination; it is sufficient to ensure adequate illumination in the room. Recommended illumination: approximately 300–600 lux.

ENVIRONMENTAL CONDITIONS

The installation zone must have the following environmental requirements:

- Allowed temperature: from 0°C to $+ 35\text{ }^{\circ}\text{C}$;
- Allowed relative humidity: from 30 % to 70 %.

POWER SUPPLY SOURCES

Arrange near the installation zone a power socket with an adequate earthing system.

The connection point for the earthing system is located on the roof of the cabinet, on the right-hand rear corner.

4.8 Location

The manufacturer’s responsibility is limited to the original components it has installed on the device, since any alterations or replacements cannot be controlled.

Any slight, non-structural or functional alterations exempt the manufacturer from any liability associated with faults, damages, malfunctions, etc., besides causing the immediate voiding of the certification, warranty and the assistance right.

Check that the cabinet is in the VERTICAL position (in relation to the opening direction of the doors) and stable.

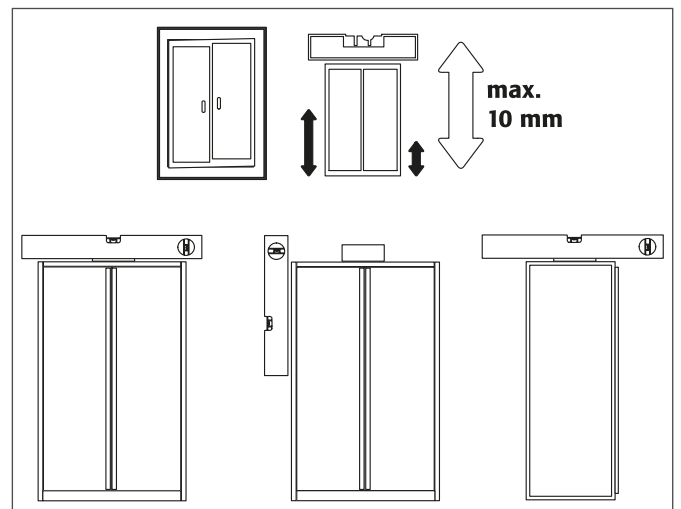

If necessary, level the cabinet by adjusting the support feet.

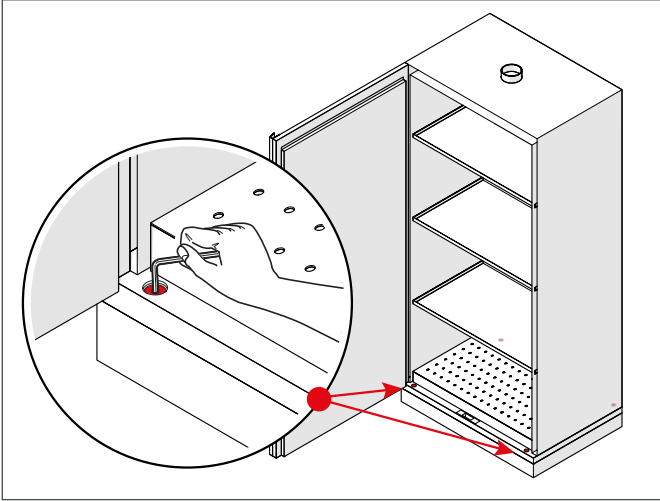

During the opening and closing phases, the door elements must not slide over the fire-protection seals near the door stops. Doors equipped with automatic closing system must close automatically from any position and the lock must be lockable.

Seal the perimeter of the cabinet base near the floor, using silicone.

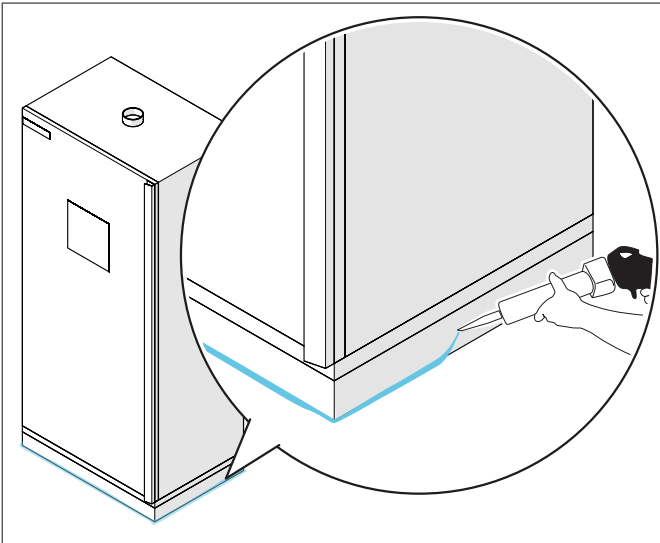

This technical prevention measure IS **NECESSARY** to block the passage of air and thus flames under the cabinet.

4.9 Internal equipment

4.9.1 Collection tray on the bottom

Loose parts (e.g. removable trays) must always be installed / inserted completely to guarantee safe closing of the cabinet doors in case of fire.

Pursuant to the EN 14470-1 standard: a collection tray (1) must be installed under the lowest support surface. The collection tray (1) must have a minimum collection volume equal to 10 % of all the containers (2) stored in the cabinet, or at least 110 % of the volume of the single largest container (3), depending on which of the two is the highest volume.

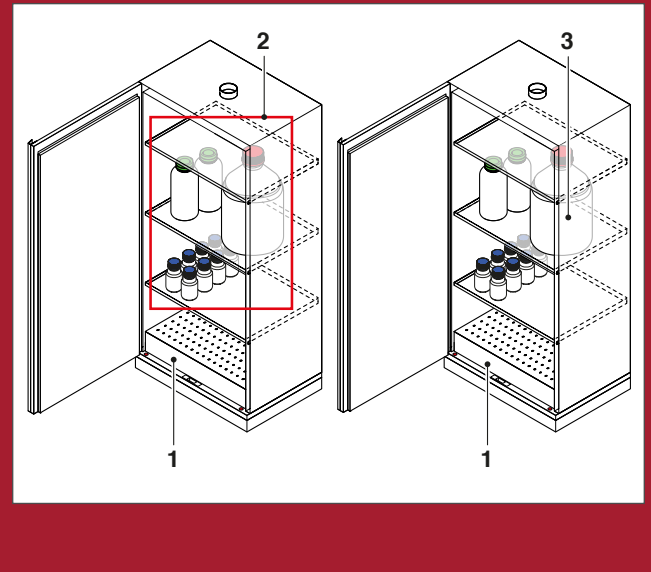

Use of the support surface of the collection tray (1) is only allowed in combination with a perforated sheet metal element.

4.9.2 Tray shelves

Loose parts (e.g. removable trays, tray shelves) must always be installed / inserted completely to guarantee safe closing of the cabinet doors in case of fire.

The height of the shelves inside the safety cabinets can only be adjusted by authorised collaborators, because it is necessary to guarantee the safe closing of the door in case of fire.

The shelves are secured by means of aluminium pegs that do not generate potential sparks.

5 USE

-  Substances that are self-igniting or subject to decomposition cannot be stored!

5.1 Usable spaces and gaps

The opening area of the cabinet doors and drawers must be kept clear at all times of any objects that can hinder their operation and use.

-  Never leave the doors and drawers open, nor hamper their automatic closing, not even when there is a system that locks the doors temporarily in the open position.

-  The cabinet must be installed, used and stored in a way that guarantees the protection of all operators, particularly against the risk of fire and explosion.

5.2 Commissioning

Before the safety cabinet is commissioned, the user must inspect it to rule out possible damages, and verify that there are no defective or detached sealing elements, its correct orientation and the efficient operation of the door components.

-  Use the cabinet and the relative accessories only if they are in perfect condition.

5.3 Storage

-  The storage of corrosive liquids can limit the functionality of important safety-related components.

- Containers housing aggressive non-flammable chemical products (acids and bases) must be placed in special cabinets or drawers for acids and bases and in safety cabinets without any metal in their interior equipment.
- Stored corrosive liquids can jeopardise the operation of the devices for blocking the delivery and exhaust air.
- Each stored container reduces the minimum requested collection volume with respect to the total storage quantity (see “4.9.1 Collection tray on the bottom” on page 16).

5.3.1 Storage capacity

The following tables specify the storage capacity of the safety cabinets on the basis of the series and model.

EN SAFETY CABINETS (TYPE 90) SERIES

DESCRIPTION	STORAGE CAPACITY*
JCB22608YL	80 / 100
JCB22609YL	160 / 200
JCB22610YL	80 / 100

(*) Approximate capacity per cabinet with 1-litre bottles

5.4 Decanting

To perform decanting operations it is **NECESSARY** to connect the decanting containers to the nearest earthing point, connected to a potential compensator, by means of cables with an earth terminal (available at electrical shops).

5.5 Tray shelves and collection tray

The powder coating and the stainless steel shelves are resistant to solvent vapours.

In case of liquid spills, the liquid must be absorbed immediately with suitable means (for further information consult the website eu.justrite.com).

The tables below specify the load-bearing capacity of the tray containers and the collection capacity of the tray supplied as standard features with the safety cabinet, on the basis of the series and model.

EN SAFETY CABINETS (TYPE 90) SERIES

DESCRIPTION	SUPPLIED ACCESSORIES	MAX LOAD CAPACITY
JCB22608YL	3 coated steel shelves	60 kg/shelf (uniformly distributed) roughly 7 litres/shelf
	1 collection tray with grille	20 litres (uniformly distributed)
JCB22609YL	3 coated steel shelves	80 kg/shelf (uniformly distributed) roughly 16 litres/shelf
	1 collection tray with grille	45 litres

JCB22610YL	3 coated steel shelves	60 kg/shelf (uniformly distributed) roughly 7 litres/shelf
	1 collection tray with grille	20 litres (uniformly distributed)



Do not exceed the overall load capacity of the cabinet (e.g. 400 kg for a 120 cm cabinet).

The collection tray (1) must have a minimum collection volume equal to 10 % of all the containers (2) stored in the cabinet, or at least 110 % of the volume of the single largest container (3), **depending on which of the two is the highest volume.**

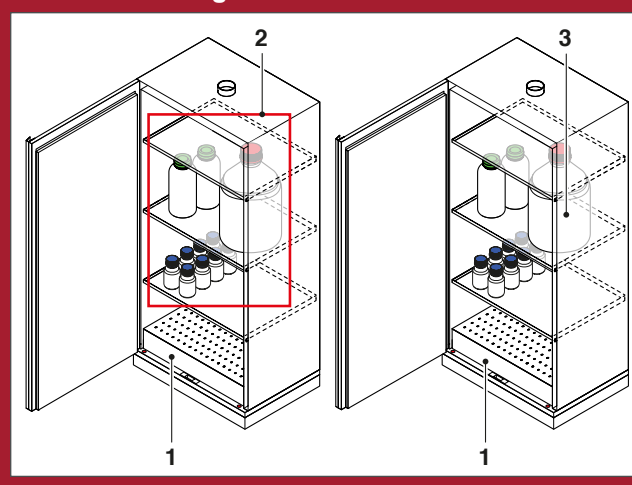

Use of the support surface of the collection tray (1) is only allowed in combination with a perforated sheet metal element.

5.6 Door closing

5.6.1 Safety cabinet version EN Safety Cabinets 90 minutes

The right or left door opens by pulling the handle.

If the ambient temperature exceeds 50 °C, the doors will close automatically.

The doors are connected to a mechanical device paired with a thermal fuse element, consisting of two identical and symmetrical metal parts (plates) welded together with a special metal alloy.

The weld melts when a temperature of 50 °C is reached, freeing the mechanical device which will then shut the doors automatically.



To replace it, contact the authorised Justrite Safety Group EMEA B.V. Technical Assistance Service.

5.6.2 Door lock

Each door is equipped with a key-operated lock.

The lock is positioned in the centre of the door.

A key is standard-supplied for each lock.

The serial number of the cabinet can be used to track the serial number of the key.



If the key breaks or is lost, a new one can be ordered also through the authorised Justrite Safety Group EMEA B.V. Technical Assistance Service.

The lock automatically locks the door at every closing movement.

Once the door is opened, if the key is extracted from the lock or is left inside it half-way down, the lock will remain in the open position and the door will not have to be unlocked at every opening movement.

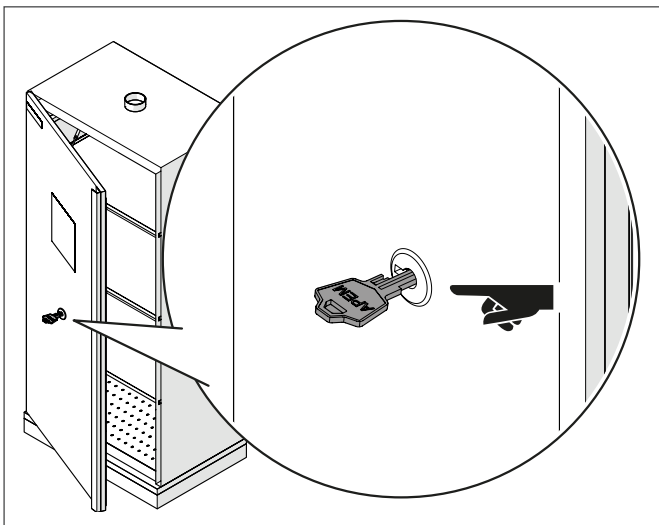

5.7 Opening the cabinet after a fire



Depending on the duration of the fire, a flammable mixture of vapour and air may have formed.

In case of fire, inform the fire brigade on the contents of the cabinet and on the circumstances that triggered the fire.

Before opening the cabinet, remove all the sources of ignition present within a 10-metre range of the cabinet.

Only use non-sparking tools.

Open the cabinets with the utmost caution and ONLY after a period of time corresponding to SIX TIMES the duration of the fire, but if the surface of the cabinet is still hot to the touch, prolong the delay.

Keep adequate extinguishing devices within reach while opening the cabinet.



We suggest using absorbent paper and/or towels arranged on the floor before proceeding with any operation (for further information consult the website eu.justrite.com).

6 MAINTENANCE

The cabinet is a piece of collective protective equipment (CPE) and must be checked at least once a year (to be done by the authorised Technical Assistance Service).

If corrosive liquids are stored, inspect the safety devices every six months (to be done by the authorised Technical Assistance Service).

Only use original spare parts.

If maintenance/servicing is performed regularly, the safety cabinet can last up to 10 years.

Certain components may need to be replaced before this term.



Each cabinet must be accompanied by the Inspections and Maintenance Register in accordance with that specified in the following paragraph.



AVOID modifying or tampering with individual parts even if they are of minor importance. Maintenance of the safety cabinet must be carried out by personnel of the authorised Technical Assistance Service.



Before approaching electrical equipment of any type, make sure that the main power supply has been **EXCLUDED**.

6.1 Inspections and Maintenance Register

The Inspections and Maintenance Register must be drawn up for each safety cabinet and must contain:

- the identification data of the safety cabinet;
- data of maintenance and efficiency inspections conducted, indicated chronologically;
- the signature of the authorised technician who carried out the operations.

The inspection and maintenance reports issued must be enclosed with the Inspections and Maintenance Register.



Further inspections and checks may be necessary whenever specified by the manufacturer and/or installer of the safety cabinet, in accordance with the instructions contained in the manual issued by the manufacturer.

6.2 Routine maintenance

Routine maintenance on a collective protection instrument is essential to safeguard the health of operators and users of the laboratory.

It involves maintenance activities and periodic inspections on the safety cabinet.

6.2.1 Daily and monthly checks to be carried out autonomously

DAILY FUNCTIONAL CHECK

- check the collection trays (absorb and remove any spills).

MONTHLY FUNCTIONAL CHECK

- efficient operation of the doors
 - hinges
 - locking systems
 - door closer (if present)
 - door locking system
- correct seating and status of the fire-protection seals
- vents
- earthing connection

Oil and grease all mobile parts, exclusively using oils free of resins and acids.



In case of damages, contact the authorised Technical Assistance Service to have the cabinet repaired with original parts. The cabinets can be cleaned using a delicate household detergent and a soft cloth.

6.3 Extraordinary maintenance

Extraordinary maintenance includes all operations such as improvement maintenance and significant preventive maintenance (including servicing, for example, which generally increases the value of systems and/or extends their working life).



Once all the operations have been completed, the authorised Technical Assistance Service must issue a validation protocol for each single cabinet containing:

- all the results measured on the field;
- the annexes of all the original certificates produced relative to the instruments used;
- an original copy conforming to the instrument calibration certificates.

7 DECOMMISSIONING

7.1 After normal use

Affix the “out of order” sign, or similar sign, to the cabinet. Leave a safety area around the cabinet measuring roughly 2 metres and 0.5 metres above the floor.

 Before starting any operation, we suggest using absorbent paper and/or towels arranged on the floor before proceeding with any operation (for further information consult the website eu.justrite.com).

The doors can now be opened.
 Remove all the products stored inside.
 Empty the tray shelves and the containment tray at the bottom of the cabinet and clean them thoroughly.
 Aerate the cabinet for at least one working day.
 With sufficient ventilation, the cabinet’s working life can be extended.

7.2 After a fire

Inform the fire brigade on the contents of the cabinet and on the circumstances that triggered the fire.

Before opening the cabinet, remove all the sources of ignition present within a 10-metre range of the cabinet.

Only use anti-sparking devices, avoid any cutting tools and flame working tools.

Open the cabinets with the utmost caution and ONLY after a period of time corresponding to SIX TIMES the duration of the fire, but if the surface of the cabinet is still hot to the touch, prolong the delay.

During opening, keep adequate extinguishing devices within reach while opening the cabinet.

 Before starting any operation, we suggest using absorbent paper and/or towels arranged on the floor before proceeding with any operation (for further information consult the website eu.justrite.com).

8 DEACTIVATION AND DISPOSAL

 If the safety cabinet is disposed of together with the lock or door locking system, MAKE SURE THAT these devices have been made unusable to prevent children from getting trapped inside.

8.1 Deactivation

If the cabinet is transferred to another storage site or once it reaches the end of its technical and service life, it must be deactivated.

It is therefore necessary to:

- switch the appliance off;
- disconnect its sources of energy;
- dismantle and separate the various units making up the appliance;

When handling the parts of the cabinet and storing them temporarily, protect the parts most at risk, such as:

Door	Use rigid packaging (wooden cage, rigid cardboard), taking extra care with the edges.
Shelves and painted parts	Wrap them in light paper and then cover the surface with plastic (light polyethylene) to protect it against moisture. Pack the parts with light cardboard to protect them against impacts.
Electrical panels and accessories	Cover them with plastic (light polyethylene) to protect them against moisture and pack them with light cardboard to protect them against impacts.

8.1.1 Precautions for storage

Place the cabinet or its components in adequately protected environments, with maximum 70 % relative humidity and temperature between 0 °C and + 35 °C.

After retrieving the cabinet from the warehouse, the following operations should be carried out before proceeding with the new installation:

- check the condition of the electrical equipment;
- contact the authorised Technical Assistance Service to check the cabinet, request the updated inspection and maintenance reports and attach them to the Inspections and Maintenance Register.

 Never leave the cabinet exposed to the elements.

 In case of doubts regarding the transport and storage, contact the authorised Technical Assistance Service.

8.2 Disposal

If the cabinet must be scrapped, separate its constituent parts accordingly for disposal.

Sort the materials according to their nature and contact specialised waste disposal companies, in accordance with the provisions of the law.

 Justrite Safety Group EMEA B.V. shall not be held liable for any harm to people or domestic animals and damage to objects deriving from the reuse of single parts of the cabinet for functions or assembly situations other than the original ones.

 The cabinet is manufactured with non-biodegradable materials. Contact authorised and specialised waste disposal companies to dispose of the parts or of the entire cabinet. Refer to the local laws on waste disposal.

8.3 Information to users

The safety cabinet for flammable materials is subject to the treatment envisaged in Art. 13, "Implementation of Directives 2002/95/EC, 2002/96/EC and 2003/108/EC relative to the reduction in the use of hazardous substances in electrical and electronic equipment, and waste disposal".

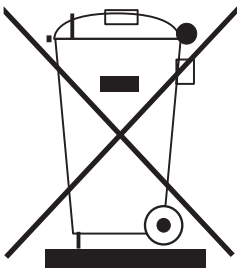



The crossed-out wheellie bin symbol appearing on the equipment or its packaging indicates that the product that has reached the end of its useful life must be collected separately from other waste. The separate collection of this equipment at the end of its life is organised and managed by the manufacturer. The user wishing to

dispose of this equipment must contact the manufacturer and follow the scheme adopted by the latter for the separate collection of equipment that has reached the end of its life. The adequate separate collection of the decommissioned equipment for its subsequent recycling, treatment and environmentally compatible disposal helps to prevent possible negative effects on the environment and human health and favours the reuse and/or recycling of the equipment's constituent materials.

 The unlawful disposal of the product by the possessor implies the application of the administrative penalties envisaged in the regulations in force.

9 TROUBLESHOOTING

 Justrite Safety Group EMEA B.V. declines all liabilities for any harm to people or domestic animals and damage to objects deriving from failure to observe the safety rules and recommendations contained in the documentation provided.

 In case of anomalies, contact the authorised Technical Assistance Service.



Worker & Workplace Safety

- Safety & Storage Cabinets
- Safety Cans & Containers
- Smoking Receptacles
- Gas Cylinder Handling Equipment
- Drum Funnels & Equipment
- Outdoor Safety Lockers

Environmental Protection

- Spill Containment
- Secondary Containment
- Aerosol Recycling

To learn more about our full portfolio of products, please visit eu.justrite.com



Justrite Safety Group EMEA B.V.

Achterzeedijk 57, Barendrecht, 2992 SB, The Netherlands

Tel. +31 (0) 180 615 744 - Fax +31 (0) 180 611 551

eu.justrite.com - saleseu@justrite.com

For use & maintenance instructions in other languages.