

ALSIPERCHA
FALL ARREST SYSTEM



ALSINA

Encofrados Alsina is a company specialized in the manufacture of formwork equipments and focused on keeping the leadership position as the most innovative formwork company developing products and solutions for the safety of workers in construction. We have designed and patented the revolutionary Alsipercha overhead fall protection system.



4000

Projects in 2018



125

Patents



800

People who work in Alsina

ALSINA IN NUMBERS

75

Alsina systems



33

Work centers



75

Own calculation programs



ISO 9001
BUREAU VERITAS
Certification
Encofrados J.Alsina, S.A.



Alsina works with the ISO 9001:2015 Certification at its centers engaged in the sale and rental of equipment for concrete formwork. The scope of this certification includes the design, manufacturing, marketing (sales and rental) and maintenance of our concrete formwork equipment. It also includes the provision of formwork equipment and scaffolding assembly services and the implementation of collective protection at work sites.

ALSIPERCHA













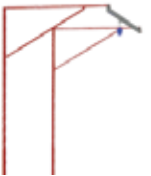



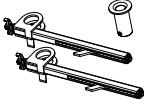









Alsipercha is a personal fall protection system, that provides an effective overhead protection for those who are exposed to falls when working at heights.

This revolutionary system, with more than 15 years of presence in the market, includes a built-in energy-absorber device (diagonal) that reduces the impact forces transmitted to the user and to the structure, in case of fall.

Thanks to a wide range of accessories, the Alsipercha can be installed in multiple situations and industrial environments, being one of the most versatile and effective overhead fall protection system of the market.

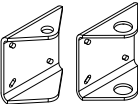
In compliance with standards: EN-795 (CE certified), OSHA/ANSI (USA) and CSA (CANADA).

ACCESSORIES AND POSSIBLE COMBINATIONS

ACCESSORIES AND POSSIBLE COMBINATIONS		ALSIPERCHA	ALUPERCHA	ALSIPERCHA RAIL
				
	Conical tube			
	Column clamps			
	Tripod			
	Counterweight MF			
	Post for reduced spaces			
	Wall bracket			

Alsipercha + Conical tube



Personal overhead fall protection system for the stage of the formwork decking process, or installation of: guardrails, gallows-type safety nets, formwork risers, and in general, all formwork assembly activities that entail the risk of falling from heights, can be carried out in an entirely safe manner.

- Provides a fall factor "0"
- Structure made of high-quality elastic steel, providing a 360° free rotation, maximizing the freedom of the worker.
- To be inserted into a conical tube pre-installed on the concrete structure (column / wall).
- Built-in energy absorber that reduces the impact forces transmitted to the user and the structure, in case of fall.
- Provides the worker with a safe area up to 125m² (aprox), and a working radius of 6,5 m.
- Combined with the use of a SRL that avoid the fall of the user.
- Steel structure of 80kgs, made of high-quality and elastic steel (elastic limits 42 - 46 Kg/mm², breaking limit 61 - 76 Kg/mm²)
- Designed to be moved and handled by crane.
- A wide range of accessories, which allows multiple applications at jobsites, is available.
- The benefit of changing from one Alsipercha to the next one with full protection, will be when the columns are distanced maximum 8,5m.



HANDLING
BY:
CRANE



USERS
x1

STANDARDS COMPLIANCE

EN:795:2012 – Type B

ANSI Z359.6 / OSHA 1926 Subp M App C – OSHA 1910 Subp I App D

CSA Z259.16

■ Preventive – Fall factor “0”



The SRL connected to the upper tube of the Alsipercha, stops the descent of the worker in case of fall.

■ Easy and quick assembly



The assembly of the Alsipercha is easy and intuitive. After a few steps, the system is ready to use.

■ Productivity



The confidence of the user that feels that is fully protected against falls when using the Alsipercha, contributes to increase the productivity. In case of fall, the user can recover the original position and continue working in just a few minutes.

■ Perimeters and high floors



Highly efficiency protecting workers against fall from heights at the most critical situations in jobsites: perimeters and high floors. Perfect to protect workers during the installation of guardrails, wooden panels or edge protection systems.

Alsipercha + Conical tube

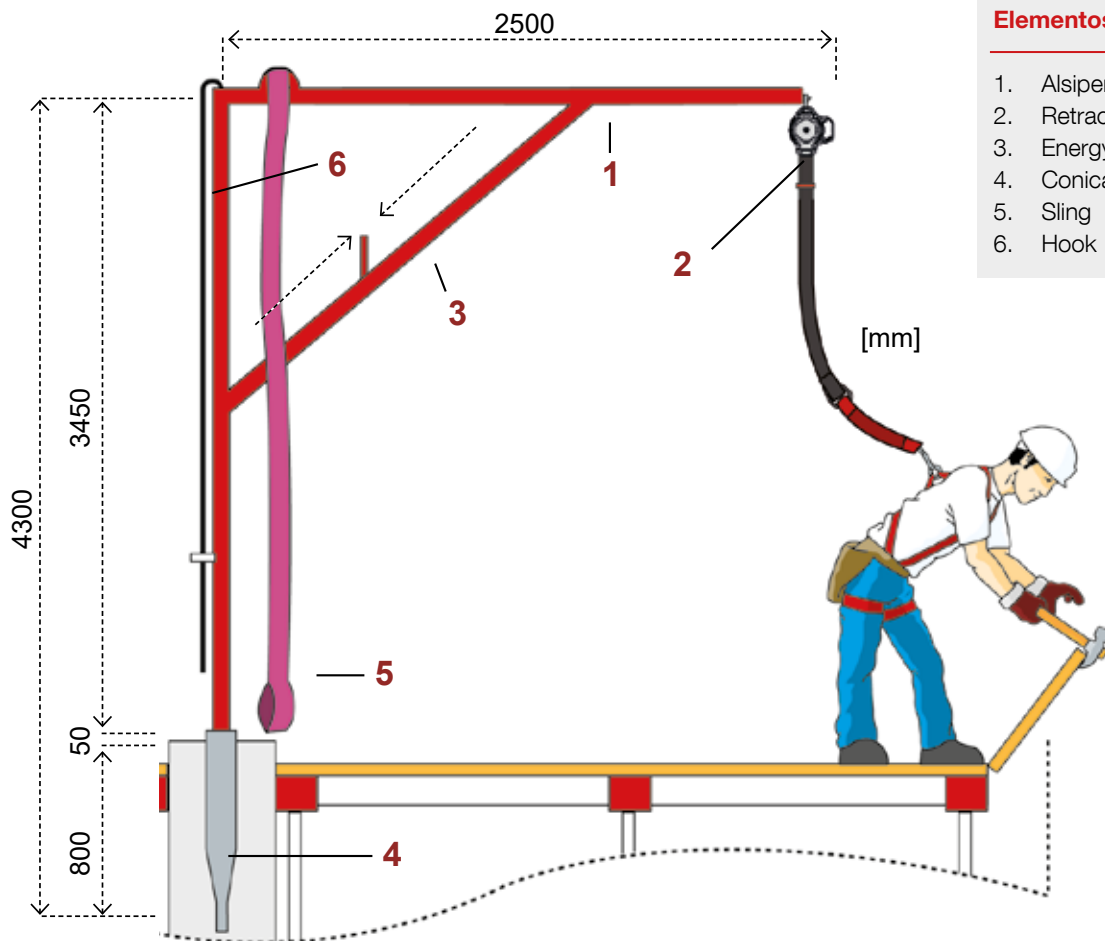

Elementos

1. Alsipercha System
2. Retractable device
3. Energy-Absorber device
4. Conical tube
5. Sling
6. Hook

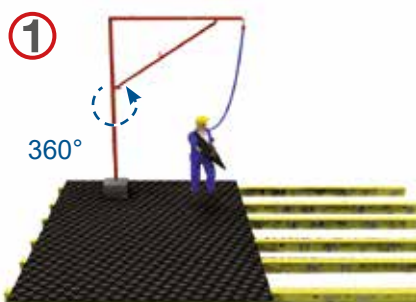

Using the Alsipercha

After connecting to the SRL and to the Alsipercha, the user can begin working and performing the panning stage, allowing a 360° safe area and a 6,5m of safe working radius.

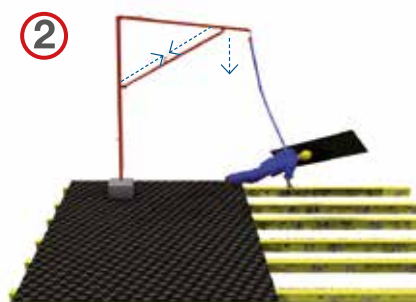

Fall of the user

In case of fall, the SRL will stop the user's fall, and the Alsipercha energy-absorber will absorb the impact forces generated.

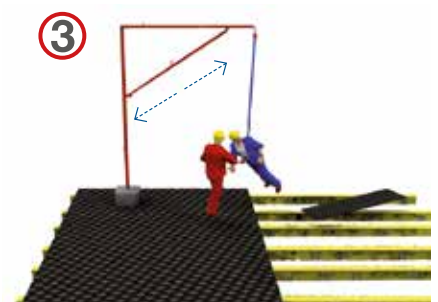

Recover process of the user after fall

The user can recover his original position and continue working, just with a simple movement and the help of another person.



HANDLING
BY:
CRANE



USERS
x1

STANDARDS COMPLIANCE

EN:795:2012 – Type B

ANSI Z359.6 / OSHA 1926 Subp M App C – OSHA 1910 Subp I App D

CSA Z259.16

1: Plan the position of the Alsiperchas

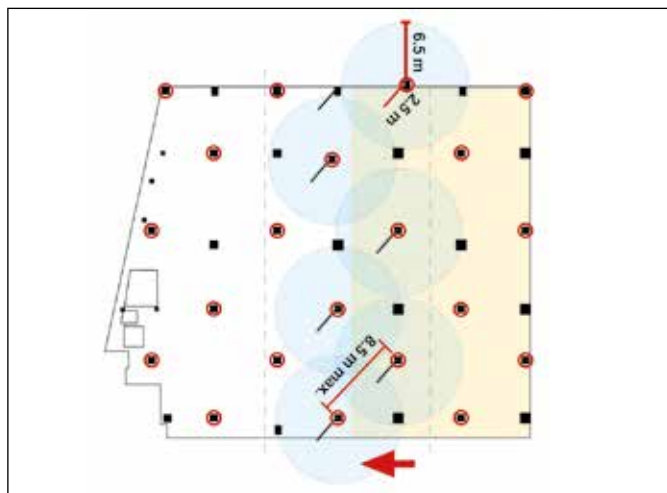

It is highly recommended to plan the area before starting the job, in order to facilitate the use of the Alsipercha.

2: Housing tube insertion



Position, level and cast the housing tube in the concrete columns. Allow for sufficient curing of concrete to enable safe operation of the system. The leveller accessory will be used to ensure the vertical position of the housing tube.

3: Use of the system



After the user is safely connected to the SRL and to the Alsipercha, the user will start to use the system. Allows a 360° safe working area with 6,5m radius from the central post (125m2 aprox).

4: Safe overlap process

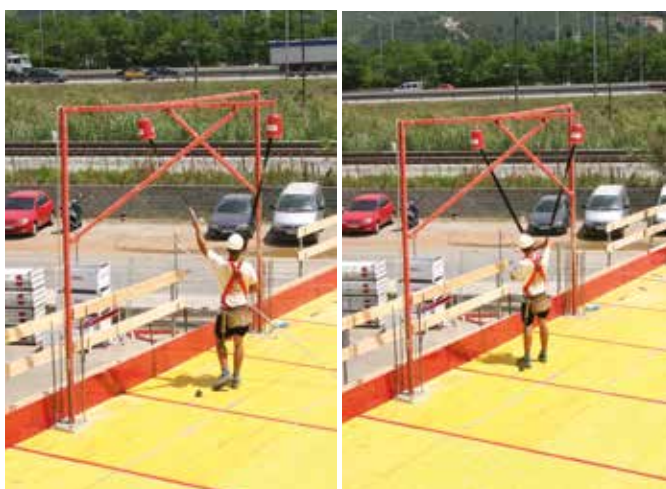

The user must never unhook himself from one Alsipercha before hooking up to the next Alsipercha. In case that the second Alsipercha is out of reach, an Alsipercha Hook is available to assist with transition.

Alupercha + Conical tube



Personal overhead fall protection system designed to be installed by hand, that protects workers against fall from heights, specially usefull for perimeters and during the decking of horizontal formwork.

Thanks to the lightweight design (just 19kgs), the Alupercha can be installed easily and fast without the need of crane, reducing costs and time. Additionally, the system can also be installed by the use of a crane if that is preferred, by using the crane connector.

Efficient overhead fall protection system for the stage of the formwork decking process, or instalation of: guardrails, gallows-type safety nets, formwork risers, and in general, all formwork assembly activities that entail the risk of falling from heights, can be carried out in an entirely safe manner.

With an easy and simple assembly process, it can be installed by a competent person.

Fully compatible with all the Alsipercha accessory range.

Features

1. Lightweight structure weighing just 19 Kg, made of high-quality elastic aluminium.
2. To be manoeuvred and installed by a single person with no lifting equipments, or the need of crane.
3. A built-in energy absorber device reduces the forces transmitted to the structure and to the user.
4. Inverted "L" shaped and 100% aluminium structure measuring 2.0 m long and 3.10 m high (2.25 m when attached to the column).
5. Allows the user to work safely covering an area of aprox 125 m² and moving within a radius of 6.0 m around the column, with the PPE length up to 4m, and aprox 230 m² when combined with PPE length up to 6,5 m (refer to the "working procedure with extended PPE" section in the UI).
6. Alupercha housing steel tube measuring 85 cm long.
7. A system designed for columns spaced up to 8,0 m.



HANDLING
BY:
HAND*



USERS
x1

STANDARDS COMPLIANCE

EN:795:2012 – Type B

* Also with crane.

1: Plan the position of the Aluperchas

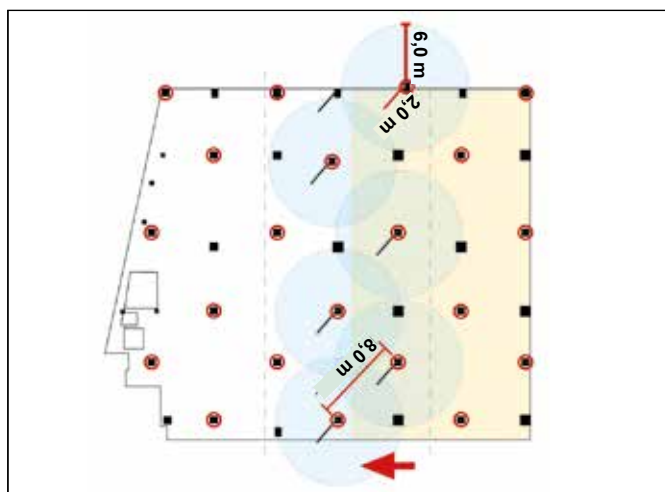

In order to facilitate the use of the Alupercha it is highly recommended to plan the area before starting the job.

2: Housing tube insertion



Position, level and cast the housing tube in the concrete columns. Allow for sufficient curing of concrete to enable safe operation of the system. The leveller accessory will be used to ensure the vertical position of the housing tube.

3: Installation and use of the system



The user will transport and insert the Alupercha into the conical tube and proceed with the system assembly. After the user is safely connected to the SRL and to the Alupercha, will start to use the system. Allows a 360° safe working area with 6,0m radius from the central post.

4: Safe overlap process



The user must never unhook himself from one Alupercha before hooking up to the next Alupercha. In case that the second Alupercha is out of reach, an Alupercha Hook is available to assist with transition.

Alsipercha + Column clamps



Whenever you have a steel column like IPE, IPN, HEB type (widths between 150 and 450 mm), then the Column Clamps accessory is the perfect solution to combine with the Alsipercha and provide an effective overhead fall protection to users.

Mainly used into industrial environments, loading or unloading trucks, doing maintenance over machines or buildings, with difficult access, the column clamp is the perfect accessory to take full advantages of the Alsipercha overhead fall protection system.

The advanced design includes an adjustable mechanism, covering the most common steel column widths on the market (open distances from 150 to 450 mm).

The column clamp accessory consists of a pair of adjustable clamps distanced by 1m, and a bottom sleeve where the Alsipercha is then going to be positioned. The installation process is quick and simple, being done in just a few steps and by the use of conventional tools.





HANDLING
BY:
CRANE



USERS
x1

STANDARDS COMPLIANCE

EN:795:2012 – Type B

ANSI Z359.6 / OSHA 1926 Subp M App C – OSHA 1910 Subp I App D

CSA Z259.16

■ Step 1



By activating the adjustable mechanism, open the jaws and increase the gap of the jaws enough to place the clamp over the steel column. Adjust the 2 column clamps to fasten them to the steel column, procuring to have a distance between them of 1m.

■ Step 2



Insert the column clamp sleeve into the lower column clamp, introducing the lug, through the grooves designed to avoid an accidental separation.

■ Step 3



Before installing the Alsipercha, adjust the column clamps, applying a maximum force of up to 50 Nxm.

■ Step 4



The column clamp accessory is ready to receive the Alsipercha. By the use of a proper lifting equipment, insert the Alsipercha through the central hole of both column clamps up to it rest at the bottom column clamp sleeve. The system is ready to use.

Alsipercha + Tripod

The TRIPOD is an accessory used to take full advantage of the Alsipercha benefits, providing an effective overhead anchor point up to 6,5m height.

With an easy, simple and fast installation process, the Tripod combined with the Alsipercha will provide full fall protection to users at a 2 possible height configurations: 5,5m with a 2m Tripod and 6,5m with a 3m Tripod.

The Tripod provides a wide range of potential uses, being specially effective for loading-unloading vehicles, a critical stage where there is a high risk of users falling from height.

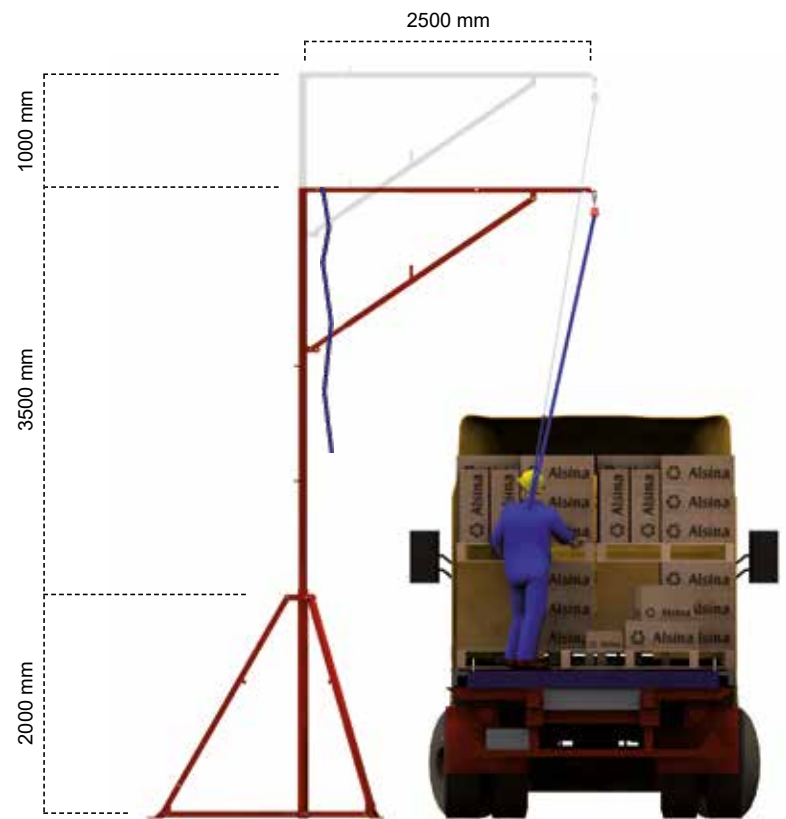



HANDLING
BY:
CRANE



USERS
x1

STANDARDS COMPLIANCE

EN:795:2012 – Type B

ANSI Z359.6 / OSHA 1926 Subp M App C – OSHA 1910 Subp I App D

CSA Z259.16

■ Step 1



Unfold and connect the 3 Tripod legs, by the use of the built-in connector.

■ Step 2



Drill and connect the anchor, tighten the nuts to ensure the firmness of the Tripod.

■ Step 3

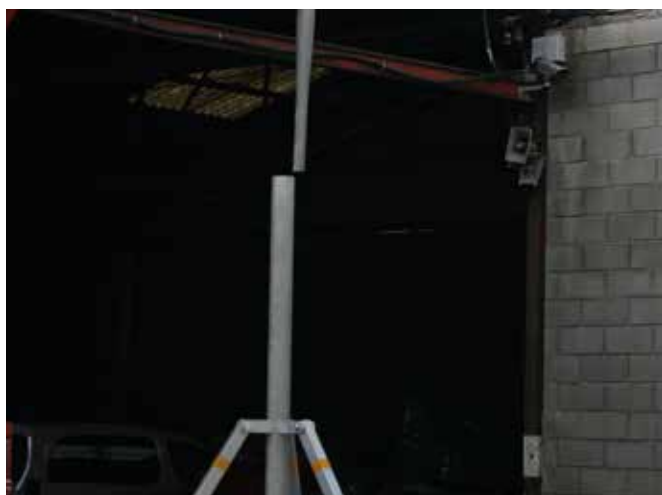

By the use of a proper lifting equipment, insert the Alsipercha through the central hole of the Tripod.

■ Step 4



The user is ready to connect to the SRL, and start using the system.

Alsipercha + Counterweight MF



The Alsipercha Counterweight MF accessory consists of a modifiable structure that guarantees an effective use of the Alsipercha when working at height over vehicles, by using the vehicle weight as counterweight.

A perfect solution, when the characteristics of the ground to be used to install an Alsipercha system are unknown, the Counterweight MF does not require to be anchored.

The advanced design, includes 3 built-in adjustable supports to correct possible unevenness on the surface.

The installation is fast, simple and intuitive, and is also available in 2 possible combinations, 5,5m height or 6,5m height.

The Counterweight MF combined with the Alsipercha, provides one of the most versatile and effective overhead fall protection solutions for those that need to work over the trucks or high vehicles.





STANDARDS COMPLIANCE

EN:795:2012 – Type B

■ Step 1



After the Counterweight MF structure is assembled, the truck wheel bases will be positioned over the 4,97m main beam.

■ Step 2



Possible unevenness on the surface can be corrected by the use of the 3 built-in adjustable supports.

■ Step 3



By the use of a proper lifting equipment, insert the Alsipercha through the central hole of the MF Axle support (main Counterweight post).

■ Step 4



The user is ready to connect to the SRL, and start using the system.

Alsipercha + Post for reduced spaces

The POST for reduced spaces allows the use of the Alsipercha in environments and zones where there are limitations of space to install other fall protection systems.

Thanks to the small dimensions and strong construction, the POST is the perfect complement to use the Alsipercha mainly within the industrial environments.

The POST for reduced spaces can be installed in just a few steps, with an easy and simple process, providing an effective overhead anchor point of 6,5 m height.

The advanced design of the POST includes a 3 positions component, to correct slight unevenness detected on the ground where is intended to be installed, to ensure a straight and correct position of the Alsipercha.

Alsipercha with POST is the perfect solution for those who need to have an effective and reliable fall protection system and has a limitation on the availability of the space to install other fall protection systems.





STANDARDS COMPLIANCE

EN:795:2012 – Type B

■ Step 1



Drill all the necessary holes that will then be used to install the POST anchors, by using the provided template for anchor holes.

■ Step 2



Select in which of the 3 positions of the POST, will rest the Alsipercha, to ensure the straightness position, and correct the possible unevenness of the ground where it is intended to be used.

■ Step 3



By the use of a proper lifting equipment, insert the Alsipercha through the central hole of the POST.

■ Step 4

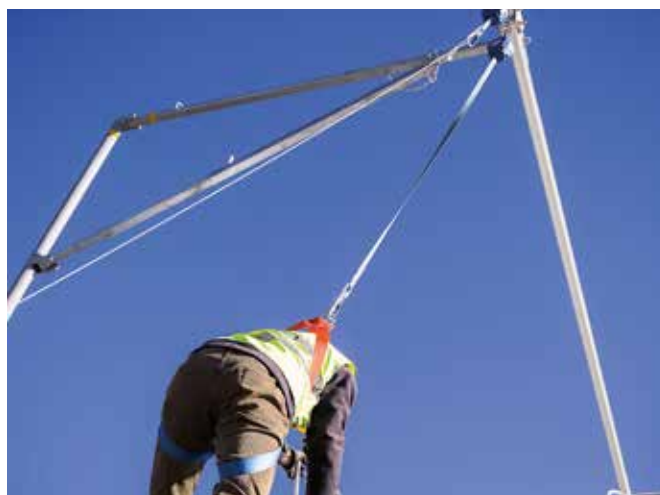

The user is ready to connect to the SRL, and start using the system.

Alsipercha + Wall bracket



Thanks to the Wall Bracket accessory, the Alsipercha can also be installed to reinforced concrete walls or columns, increasing the range of multiple applications of the Alsipercha significantly. The installation of the wall brackets can be performed in just a few steps, thanks to the intuitive holes and simplicity of the installation process.

The wall bracket accessory consists of a pair of brackets, procuring to have a distance between them of 1m, that will later lodge the Alsipercha.

Thanks to the Wall Bracket accessory, you can have in a few minutes an effective and reliable fall protection system, to protect workers exposed to the hazard of falls from height during the performance of their work.

Loading - unloading vehicles, preparing tanker trucks, cleaning or maintenances over machines, are some of the main activities that can be done in a safe manner with this combination.

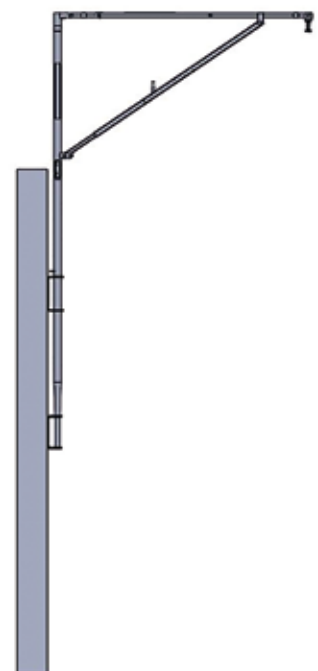



STANDARDS COMPLIANCE

EN:795:2012 – Type B

■ Step 1

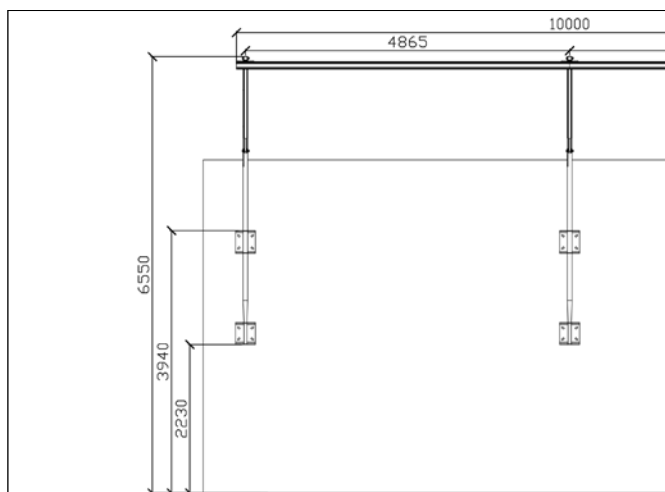

Drill all the necessary holes that will then be used to install the wall brackets anchors, setting in advance the height to which it will be intended to use the Alsipercha.

■ Step 2



Fasten and tighten all the wall brackets anchors after the installation of the upper and lower wall brackets at the desired height on the concrete wall/column.

■ Step 3



Insert the Alsipercha through the central hole of the upper wall bracket, making sure that it passes through the two holes correctly, and then pass through the central hole of the lower wall bracket, up to the bottom inner part where will rest the Alsipercha.

■ Step 4



The user is ready to connect to the SRL, and start using the system.

Alsipercha + Rail

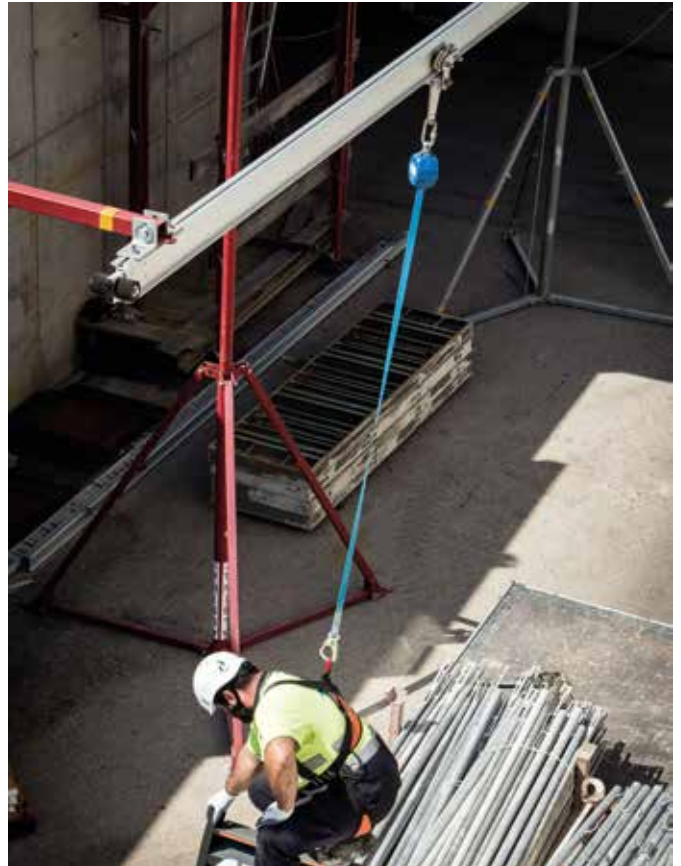

The Alsipercha RAIL is the combination of the full range of Alsipercha accessories available, with an ATEX certified rigid lifeline that eliminates the possible pendulum effect in case of the fall of a user when working at height.

Perfect for the use into industrial environments, where the work over tanker trucks continues to be a critical task, the Alsipercha RAIL provides an effective and reliable fall protection solution at 6.5m height, admitting up to 2 users simultaneously (for a maximum length of 12m).

The SRL connected to a trolley slides through the RAIL rigid lifeline, following the user at all times and standing permanently above the user's head, reducing the potential pendulum effect produced in case of fall.

Available in two possible standard combinations (6 or 12 ml), it also allows extensions in 6ml batches, and offers the possibility of assembly in a FIXED or FOLDABLE format, for those who need to move the whole system without interfering with other elements (like overhead cranes, rail catenaries).

With a simple and easy installation process, it can be assembled and installed in just a few hours (depending on the combination of Alsipercha accessory selected).

Thanks to the wide variety of multiple combinations, its innovative design, maximum versatility and multiple advantages, the Alsipercha RAIL is considered a reference for those seeking to obtain the maximum level of protection for workers exposed to the risk of fall from heights.

AVAILABLE COMBINATIONS	Alsipercha	+ Column clamps	+ Rail
		+ Tripod	
		+ Counterweight MF	
		+ Post for reduced spaces	
		+ Wall bracket	



STANDARDS COMPLIANCE

EN:795:2012 – Type D

■ **Step 1**



Once the zone where the Alsipercha is going to be used is selected and prepared, select and install the Alsipercha chosen accessory.

■ **Step 2**



By the use of a proper lifting equipment, insert the Alsipercha into the accessory selected and installed in Step 1.

■ **Step 3**



By the use of a proper lifting equipment, connect the Alsipercha RAIL connector chosen (FIX/FOLDABLE) and the RAIL batches together with SRL Trolley and SRL.

■ **Step 4**



The user is ready to connect to the SRL, and start using the system.

Accessories and possible combinations



Alsupercha + Conical tube



Alupercha + Conical tube



Alsupercha + Column clamps



Alsupercha + Tripod



Alsupercha + Counterweight MF



Alsupercha + Post for reduced spaces



Alsipercha + Wall bracket



Alsipercha + Column clamps + Rail



Alsipercha + Tripod + Rail



Alsipercha + Post for reduced spaces + Rail



Alsipercha + Wall bracket + Rail





Alsina
FORMWORK SOLUTIONS

Alsina Group
Tel. (+34) 935 753 000
Web: www.alsina.com
Mail: alsinainfo@alsina.com

www.alsipercha.com
www.alsina.com

