

Plan/Plan/Draufsicht

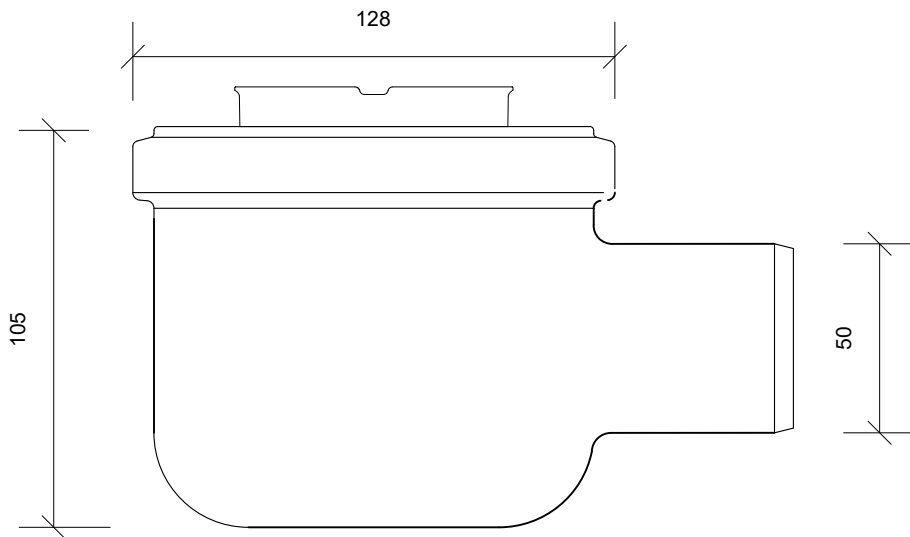

Side Opstalt/Side Elevation/Seitenansicht

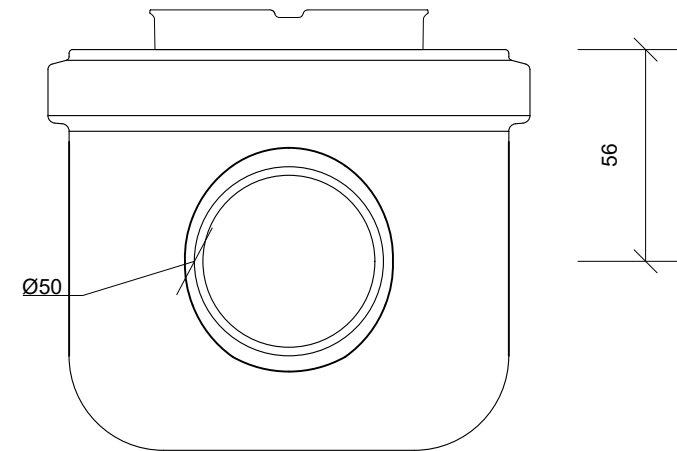

Front Opstalt/Front Elevation/Frontansicht

Unidrain 2000 Line

DK Udløbshus | hjørne | Ø 50 mm vandret, inkl. vandlås
 EN Outlet unit | corner | Ø 50 mm horizontal, incl. water trap
 DE Ablaufgehäuse | Ecke | Ø 50 mm horizontal, inkl. Geruchsverschluss



2014-10-01

1:2

Rev.

Art-no.

2411.0050