

# Installation, Operation & Maintenance Guide

BSP/PN6/10/16 Connections

**Swimming Pool Heat Exchangers**



**BOWMAN**®

100 YEARS OF HEAT TRANSFER TECHNOLOGY

# Foreword

## Dear customer,

Thank you for purchasing a high quality Bowman swimming pool heat exchanger.

**Bowman** have been manufacturing swimming pool heat exchangers for over 60 years and are acknowledged as the brand leader due to their quality, heat transfer performance and durability.

Please read this Installation, Operation & Maintenance guide fully and carefully before installation to ensure your Bowman swimming pool heat exchanger operates efficiently and reliably.

Please keep this guide for future reference to ensure the long term performance of your Bowman swimming pool heat exchanger.

Should you require additional advice or assistance, please contact your Bowman stockist or dealer.

Installation, Operation & Maintenance guides are also available in:



French



German



Italian



Spanish



Polish



Russian



Chinese

If you require a copy of this guide in one of these languages, visit

<https://ej-bowman.com/downloads/> where copies are available to download.

## All rights reserved

E.J. Bowman (Birmingham) Ltd, reserve the right to change specifications without prior notice. All material contained in this brochure is the intellectual property of EJ Bowman (Birmingham) Ltd. It is protected under copyright and may not be reproduced without prior written consent of the company.

## Warranty

All **BOWMAN**® Swimming Pool Heat Exchangers are guaranteed against manufacturing faults for a period of 12 months from the date of invoice.

Bowman titanium heat exchangers have a full 10 year guarantee on all titanium material in contact with pool water.

For full warranty terms, please see the **BOWMAN**® Conditions of Sale. A copy of which is available on request or can be downloaded from our website: [www.ej-bowman.com](http://www.ej-bowman.com)

# Contents

<b>Foreword</b>	<b>2</b>
<b>1. Safety</b>	
1.1 Hazards when handling the heat exchanger	4
1.2 Safety instructions	4
1.3 Approved use	5
1.4 Potential hazards	5
1.5 Safety measures at installation site	5
<b>2. Installation</b>	
2.1 Transport / storage	6
2.2 Installation	6
2.3 Fitting	6
2.4 Connecting the heat exchanger	7
2.5 Counter flow installation	8
2.6 Integral thermostat pocket	8
<b>3. Operation</b>	<b>8</b>
<b>4. Commissioning</b>	<b>9</b>
<b>5. Maintenance / Repair</b>	
5.1 Winter shut-down in frost free areas	9
5.2 Winter shut-down in areas exposed to frost	9
5.3 General Maintenance	9
<b>6. Specifications</b>	<b>10</b>
<b>7. Spare Parts List</b>	<b>11</b>

# 1. Safety

## 1.1 Hazards When Handling the Heat Exchanger

**BOWMAN**® “Swimming Pool Heat Exchangers” are constructed in accordance with current practice and recognised safety rules. Hazards may still arise from operation, such as:

- Injury of the operator or
- Third parties or
- Damage to the heat exchanger or
- Damage to property and equipment

Any person involved with the installation, commissioning, operation, maintenance or repair of the heat exchanger must be:

- Physically and mentally capable of performing such work
- Appropriately qualified
- Comply completely with the installation instructions

The heat exchanger must only be used for this purpose.

In the event of breakdowns which may compromise safety, a qualified plumber must always be contacted.

## 1.2 Safety Instructions

The following symbols are used in these operating instructions:



Danger

This symbol indicates an immediate danger to health.  
Failure to comply with this instruction may result in severe injury.



Caution

This symbol indicates a possible danger to health.  
Failure to comply with this instruction may result in severe injury.



Take Care

This symbol indicates a possible risk to health.  
Failure to comply with this instruction may result in injury or damage to property.



This symbol indicates important information about correct handling of the equipment.  
Failure to comply with this instruction may cause damage to the heat exchanger and/or its surroundings.

### 1.3 Approved Use



**BOWMAN**® “Swimming Pool Heat Exchangers” are only approved for heating or cooling pools with boiler water, solar and heat pump systems. Any other use unless agreed by **BOWMAN**® is not approved. We decline all liability for damage associated or arising from such use.

The maximum working pressure is:

Heating/Cooling Side	:	6 bar
Pool Water Side	:	6 bar

The maximum working temperature is:

Heating/Cooling Side	:	110 °C
Pool Water Side	:	100 °C

### 1.4 Potential Hazards



Take Care

The heat exchanger may be damaged or leak if the maximum working pressure is exceeded.

Connections on the heating water side of the heat exchanger may reach temperatures as high as 110°C.



Caution

The heat exchanger may heat up to the flow temperature of the heating water if there is no pool water flowing through the heat exchanger. Any plastic pipe work may be exposed to excessive temperature and suffer damage.

### 1.5 Safety Measures at Installation Site



Take Care

The heat exchanger should be installed in a frost free enclosure.

Ensure the maximum working pressure on either side of the heat exchanger is not exceeded or the heat exchanger or surrounding equipment may be damaged.



While the pool is in operation, weekly inspection of the heat exchanger and its connections should be made to check for leaks and external damage.

# 2. Installation

## 2.1 Transport / Storage

The heat exchanger must be drained prior to transportation. Once drained and dry, the heat exchanger must only be stored indoors in a non-aggressive atmosphere.

## 2.2 Installation

The heat exchanger should only be installed in a frost-free, dry area with a non aggressive atmosphere. Ensure easy access for assembly/disassembly.

## 2.3 Fitting

Before fitting, check the heat exchanger for damage, the heat exchanger can be installed above or below the pool water level, positioned horizontally or vertically, as shown below.



Take Care



Take Care

### Horizontal Mounting

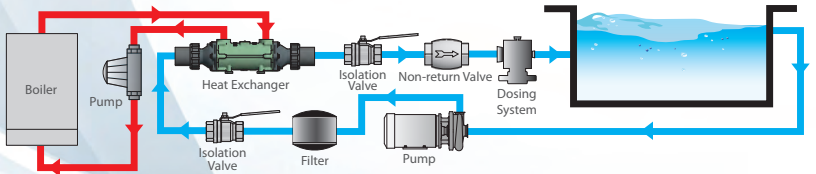

### Vertical Mounting

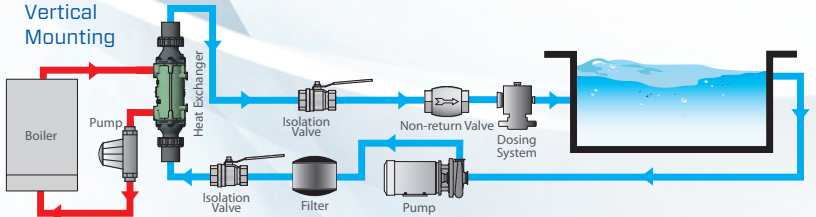

The heat exchanger may be damaged by chemicals. Dosing systems must be fitted downstream from the heat exchanger incorporating a non return valve. If chemicals are used, gases must be prevented from entering the heat exchanger when the filtration system is not in use.

The heat exchanger should always be installed downstream of the pumping and filtration equipment. The boiler/solar water must be pump assisted and the usual precautions taken to prevent air locks. It is recommended that an inhibitor is added to the boiler circuit to protect the system against corrosion.

The heat source should be controlled by a thermostat in the pool water pipe before the heat exchanger and set at the required pool temperature.

## 2.4 Connecting the Heat Exchanger



Close all isolating valves in the flow and return pipes of both circuits.  
Ensure compliance with water quality and maximum permissible pressures.

When fitting the heat exchanger into the pipe work care must be taken to ensure that no debris has been introduced into the heat exchanger.

Please refer to the table below for the pool water and boiler/solar water connections.

Metric	Universal Fit	Individual Fit					
Type	EC	FC	FG	GL	GK	JK	PK
<b>Pool Water Connection</b>	Solvent Weld Ø48/Ø50mm (DN40 Pipe)	Solvent Weld Ø60.3/Ø63mm (DN50 Pipe)	Threaded 2½" BSP	Threaded 3" BSP	Flanged PN6/10/16 DN100	Flanged PN10/16 DN125	Flanged PN10/16 DN150
<b>Boiler / Solar Water Connection</b>	Threaded ¾" BSP	Threaded 1" BSP	Threaded 1¼" BSP	Threaded 1½" BSP	Threaded 2" BSP	Threaded 2½" BSP Flanged PN6 - DN80	PN6 - DN100

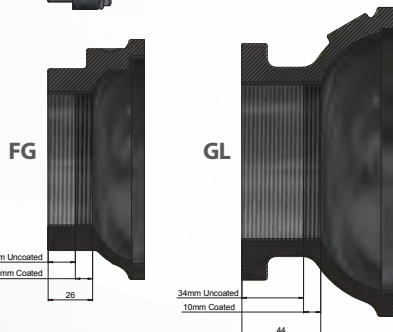
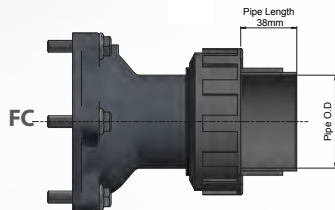
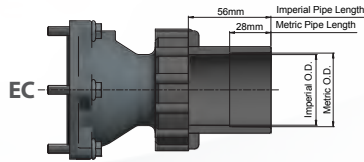

### Important pool water connection information

**EC heat exchangers;** feature 'Universal Fit' end covers designed to accommodate both metric and imperial pipe. For metric 50mm (DN40) pipe, there is a 28mm deep recess to secure the pipe to the end cover. For imperial 1½" NPS pipe, there is a 56mm deep recess to secure the pipe to the end cover. When installing 1½" NPS it is important to locate sufficient pipe length into the full recess in order to ensure a water tight seal between the pipe and the end cover. Please refer to diagram below for more details.

**FC heat exchangers;** are supplied with adaptors which enable either 63mm (DN50) metric pipe, or 2" NPS (60.3mm) imperial pipe to be used. There is a 38mm deep recess to secure the pipe in the end cover for both pipe sizes. Please refer to diagram for more information.

**FG & GL heat exchangers;** when connecting an FG or GL heat exchanger to the pool water, always ensure that sufficient connecting pipe thread goes into the end cover to enable it to engage with the black coated thread. This prevents the uncoated thread being exposed to the pool water.

## 2.5 Counter flow installation

The heat exchanger must be installed in counter flow – i.e. where the pool water flows in the opposite direction to the heating water as shown below.

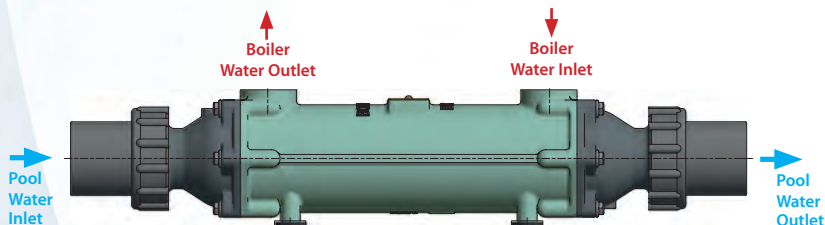

**NOTE:** failure to install the heat exchanger in this arrangement will reduce the performance.

## 2.6 Integral thermostat pocket

Most Bowman swimming pool heat exchangers have an integral thermostat pocket. To ensure accurate monitoring of the pool water temperature it is important to install the thermostat on the pool water inlet to the heat exchanger.

# 3. Operation

It is essential that the following instructions are followed to prevent corrosion/erosion of the heat exchanger:

- a) **BOWMAN**® Stainless Steel heat exchangers should not be used with salt water chlorinators or salt water pools. ( Cupro Nickel or Titanium is available for these applications).
- b) Always maintain the water pH to within correct levels. The ideal pool pH should be kept within 7.4 to 7.6. On no account should it fall below 7.2 or rise above 7.8. Checks should be made daily. Recommended chemical limits for **BOWMAN**® Swimming Pool Heat exchangers are shown below, however any local swimming pool water guidelines should be followed for safe bathing.



Take Care

Material	Cupronickel	Stainless Steel	Titanium
Free Chlorine	1.0 - 3.0 ppm	1.0 - 3.0 ppm	15.0 ppm max.
pH	7.2 - 7.8	7.2 - 7.8	6.8 - 8.0
Calcium Hardness	200 - 400 ppm	200 - 1000 ppm	200 - 1000 ppm
Alkalinity	100 - 150 ppm	100 - 150 ppm	100 - 150 ppm
Bromine	2.0 - 4.0 ppm	2.0 - 4.0 ppm	15.0 ppm max.
Chloride	Less than 150 ppm	Less than 350 ppm	Less than 3000 ppm

- c) If a by-pass is fitted, it is essential that any valves are positioned to allow the recommended pool water flow to pass through the heat exchanger.



- d) The filter unit should be checked regularly, especially if sand filters are used. If sand filters are not working correctly, fine particles of sand can flow round the pool circuit causing erosion of the pipe work, heat exchanger and pump.
- e) Keep the pool free from debris such as leaves, grass cuttings etc. Foreign matter can decay and increase the pH level in the pool.
- f) It is essential that the correct amount of chemical is added to the pool. To allow proper dispersion of the dose in the pool water, distribution of the dose should be made to various areas of the pool. Do not dose in one area only, especially adjacent to the pool water return as this will create high acidic areas which can cause corrosion/erosion of the pool equipment.

## 4. Commissioning



Take Care



Danger



Commissioning of the heat exchanger should not be undertaken until this document has been read and understood.

Both circuits of the heat exchanger must be connected before commissioning.

Adequate provision should be made to ensure that correct operating equipment along with personal protection (PPE) in accordance with current standards is used.

## 5. Maintenance / Repair



### 5.1 Winter Shutdown in Frost Free Areas

When shut down in frost free premises the heat exchanger must be completely full of water and purged of air.



### 5.2 Winter Shutdown in Areas Exposed To Frost

Care should be taken to prevent frost damage from a winter shutdown in premises exposed to frost. We recommend draining the heat exchanger or removing it from the installation for the shutdown period.

### 5.3 General Maintenance

The heat exchanger should require little attention in service, however if cleaning or replacement of the tube stack is necessary the end cover screws should be tightened to the torque figures below. Note, new seals are recommended if the end covers are removed.

Type	EC Series	FC Series	FG Series	GL	GK	JK	PK
Screw Size	M6	M8	M8	M10	M12	M16	M16
Torque (Nm)	8	16	22	37	54	95	130

## 6. Typical performance with boilers...

Type	Pool Capacity		Heat Transfer 82°C Boiler Water		Heat Transfer 60°C Boiler Water		Boiler Water Flow		Maximum Pool Water Flow		Weight
	m <sup>3</sup>	gal	kW	Btu/h	kW	Btu/h	m <sup>3</sup> /h	l/m	m <sup>3</sup> /h	l/m	kg
EC80-5113-1C	40	8,800	20	68,000	12	41,000	2.1	35	9.0	150	3.0
EC80-5113-1S/T*	50	11,000	25	85,000	16	55,000	3.0	50	12.0	200	3.0 / 2.7
EC100-5113-2C	80	18,000	40	135,000	22	75,000	2.4	40	10.2	170	4.5
EC100-5113-2S/T*	90	20,000	50	170,000	30	102,000	3.0	50	12.0	200	4.5 / 4.0
EC120-5113-3C	120	26,000	70	240,000	40	135,000	3.6	60	13.5	225	5.5
EC120-5113-3S/T*	130	28,500	80	270,000	46	157,000	4.0	67	15.0	250	5.5 / 4.9
FC100-5114-2C	170	37,000	100	340,000	55	190,000	5.4	90	21.0	350	8.8
FC100-5114-2S/T*	180	39,500	110	375,000	60	205,000	6.0	100	22.8	380	8.8 / 7.8
FG100-5115-2C	230	50,000	170	580,000	100	340,000	7.2	120	28.8	480	16
FG100-5115-2S/T*	250	55,000	190	650,000	110	376,000	8.4	140	33.0	550	16 / 14
FG160-5115-5S/T*	320	70,000	300	1,000,000	170	580,000	9.6	160	39.0	650	29 / 25
GL140-3708-2C	455	100,000	300	1,000,000	170	580,000	12.6	210	50.4	840	30
GL140-3708-2T	478	105,000	320	1,100,000	180	615,000	13.5	225	54.0	900	30 / 27
GK190-5117-3C	660	145,000	556	1,900,000	310	1,060,000	19.2	320	75.0	1,250	57
GK190-5117-3T	750	165,000	630	2,150,000	360	1,230,000	21.6	360	96.0	1,600	51
JK190-5118-3C	1,000	220,000	780	2,660,000	440	1,500,000	28.6	475	114.0	1,900	85
JK190-5118-3T	1,230	270,000	960	3,280,000	540	1,840,000	37.5	625	150.0	2,500	76
PK190-5119-3C	1,500	330,000	1,055	3,600,000	585	2,000,000	44.0	730	175.0	2,900	120
PK190-5119-3T	1,680	370,000	1,170	4,000,000	650	2,200,000	49.2	820	216.0	3,600	106

\*Add the appropriate suffix indicating tube material when ordering these part numbers (S or T).

C = Cupronickel S = Stainless steel T = Titanium. N.B. Stainless steel heat exchangers should not be used on pools fitted with salt water chlorinators or salt water pools. The performance capabilities of the heat exchangers are based on achieving a pool water temperature of 30°C.

## ... and with solar panels & heat pumps

Type	Pool Capacity		Heat Transfer		Solar or Heat Pump Water Flow		Maximum Pool Water Flow		Weight	
	m <sup>3</sup>	gal	kW	Btu/h	m <sup>3</sup> /h	l/m	m <sup>3</sup> /h	l/m	kg	
<b>Hot Water at 70°C</b>										
EC120-5113-3C/S/T*	50	11,000	30	102,000	1.5	25	6.2	104	5.5 / 5.5 / 4.9	
EC160-5113-5C/S/T*	120	26,000	75	256,000	3.0	50	15.0	250	8.5 / 8.5 / 7.3	
FC160-5114-5C/S/T*	200	44,000	130	444,000	4.5	76	23.0	380	17 / 17 / 15	
FG160-5115-5C/S/T*	300	66,000	200	680,000	6.6	110	29.0	480	29 / 29 / 25	
<b>Hot Water at 60°C</b>										
EC120-5113-3C/S/T*	40	8,800	20	68,000	1.5	25	6.2	104	5.5 / 5.5 / 4.9	
EC160-5113-5C/S/T*	110	24,000	55	190,000	3.0	50	15.0	250	8.5 / 8.5 / 7.3	
FC160-5114-5C/S/T*	180	40,000	96	325,000	4.5	76	23.0	380	17 / 17 / 15	
FG160-5115-5C/S/T*	230	50,000	150	512,000	6.6	110	29.0	480	29 / 29 / 25	
<b>Hot Water at 45°C</b>										
EC120-5113-3C/S/T*	20	4,400	10	34,000	1.5	25	6.2	104	5.5 / 5.5 / 4.9	
EC160-5113-5C/S/T*	52	11,400	27	92,000	3.0	50	15.0	250	8.5 / 8.5 / 7.3	
FC160-5114-5C/S/T*	94	20,600	47	160,000	4.5	76	23.0	380	17 / 17 / 15	
FG160-5115-5C/S/T*	140	30,800	70	240,000	6.6	110	29.0	480	29 / 29 / 25	

\*Add the appropriate suffix indicating tube material when ordering these part numbers (C, S or T).

C = Cupronickel S = Stainless steel T = Titanium N.B. Stainless steel heat exchangers should not be used on pools fitted with salt water chlorinators or salt water pools.

# 7. Spare Parts List

We keep a comprehensive stock of spare parts. Please contact our sales department for details.

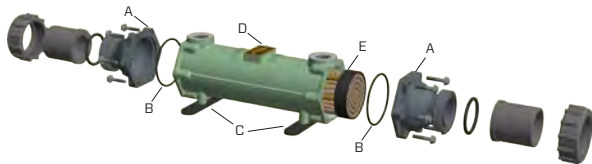

## EC Spare Parts

Type	End Cover Assembly (A)	'O' Seals (B)	Mounting Brackets (C)	Body (D)	Tube Stack (E)
EC80-5113-1C EC80-5113-1S EC80-5113-1T	5030-1	AN12NT	5032-1	EC69-5568-1CI	5095-1TNP 5095-1STP 5095-1TIP
EC100-5113-2C EC100-5113-2S EC100-5113-2T	5030-1	AN12NT	5032-1	EC70-4568-2CI	5095-2TNP 5095-2STP 5095-2TIP
EC120-5113-3C EC120-5113-3S EC120-5113-3T	5030-1	AN12NT	5032-1	EC71-4568-3CI	5095-3TNP 5095-3STP 5095-3TIP
EC160-5113-5C EC160-5113-5S EC160-5113-5T	5030-1	AN12NT	5032-1	EC73-4568-5CI	5095-5TNP 5095-5STP 5095-5TIP

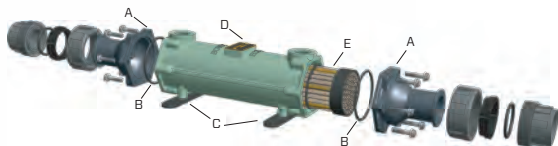

## FC Spare Parts

Type	End Cover Assembly (A)	'O' Seals (B)	Mounting Brackets (C)	Body (D)	Tube Stack (E)
FC100-5114-2C FC100-5114-2S FC100-5114-2T	5031	OS46NT	5032-2	FC70-4668-2CI	5096-2TNP 5096-2STP 5096-2TIP
FC160-5114-5C FC160-5114-5S FC160-5114-5T	5031	OS46NT	5032-2	FC73-4668-5CI	5096-5TNP 5096-5STP 5096-5TIP

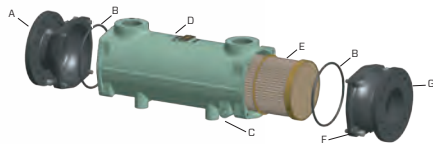

## FG, GL, GK, JK & PK Spare Parts

Type	Non Drain End Cover (A)	'O' Seals (B)	Mounting Brackets (C)	Body (D)	Tube Stack (E)	End Cover Screws (F)	Drain End Cover (G)
FG100-5115-2C FG100-5115-2S FG100-5115-2T	FG7-2802CIC-DR	OS52NT	5032-2	FG10-1650-2CI	5090-2TN1P 5097-2STP 5097-2TIP	HS08X35DP	FG7-2802CIC-DR
FG160-5115-5C FG160-5115-5S FG160-5115-5T	FG7-2802CIC-DR	OS52NT	5032-2	FG16-1650-5CI	5090-5TN1P 5097-5STP 5097-5TIP	HS08X35DP	FG7-2802CIC-DR
GL140-3708-2C GL140-3708-2T	GL37-3140CIC	OS63NT	-	GL15-3136NF-2CI6	3447-2TN1B 5367-2TI4B	HS10X40DP	GL37-3140CIC-DR
GK190-5117-3C GK190-5117-3T	GK65-5255CIC	OS69NT	-	GK19-2865NF-3CI7	3448-3TN1B 5369-3TI4B	HS12X50DP	GK65-5255CIC-DR
JK190-5118-3 JK190-5118-3T	JK4-3331CIC	OS74NT	-	JK19-3332NF-3CI8	3450-3TN1B 5371-3TI4B	HS16X70DP	JK4-3331CIC-DR
PK190-5119-3 PK190-5119-3T	PK4-2926CIC	OS81NT	-	PK19-2920HF-3CI0	3449-3TN1B 5373-3TI4B	HS16X70DP	PK4-2926CIC-DR

When an end cover is removed for cleaning or maintenance, a new 'O' seal should be fitted.

# Bowman heat transfer solutions

Bowman is now established as the leading manufacturer of swimming pool heat exchangers. With tens of thousands of units operating reliably and efficiently throughout the world, you can have complete confidence when you specify Bowman heat exchangers.

Additionally, Bowman heat exchangers and oil coolers can be found in Active Fire Protection Systems, Automotive Engine Testing, Combined Heat & Power, Hydraulic Systems, Marine Engineering, plus Mining Equipment and Machinery, in a range that includes:



Exhaust Gas Heat Exchangers



Hydraulic Oil Coolers



Charge Air Coolers



Stainless Steel Heat Exchangers



Header Tank Heat Exchangers



Plate Heat Exchangers



Transmission Coolers



Engine Oil Coolers



## **EJ Bowman (Birmingham) Ltd**

Chester Street, Birmingham B6 4AP, UK

Tel: +44 (0) 121 359 5401

Fax: +44 (0) 121 359 7495

Email: [sales@ej-bowman.com](mailto:sales@ej-bowman.com)

[www.ej-bowman.com](http://www.ej-bowman.com)

**BOWMAN**<sup>®</sup>  
100 YEARS OF HEAT TRANSFER TECHNOLOGY



FM38224

L21