



RELIANCE Omni 1-Dome,
8-inch

User Manual

UM-5073, Rev. 1.0, 2021/07/13



A.0 Disclaimer / Standard Warranty

CE certification

The equipment listed as CE certified means that the product complies with the essential requirements concerning safety and hygiene. The European directives that have been taken into consideration in the design are available on written request to ADB SAFEGATE.

ETL certification

The equipment listed as ETL certified means that the product complies with the essential requirements concerning safety and FAA Airfield regulations. The FAA directives that have been taken into consideration in the design are available on written request to ADB SAFEGATE.

All Products Guarantee

ADB SAFEGATE will correct by repair or replacement per the applicable guarantee above, at its option, equipment or parts which fail because of mechanical, electrical or physical defects, provided that the goods have been properly handled and stored prior to installation, properly installed and properly operated after installation, and provided further that Buyer gives ADB SAFEGATE written notice of such defects after delivery of the goods to Buyer. Refer to the Safety section for more information on Material Handling Precautions and Storage precautions that must be followed.

ADB SAFEGATE reserves the right to examine goods upon which a claim is made. Said goods must be presented in the same condition as when the defect therein was discovered. ADB SAFEGATE further reserves the right to require the return of such goods to establish any claim.

ADB SAFEGATE's obligation under this guarantee is limited to making repair or replacement within a reasonable time after receipt of such written notice and does not include any other costs such as the cost of removal of defective part, installation of repaired product, labor or consequential damages of any kind, the exclusive remedy being to require such new parts to be furnished.

ADB SAFEGATE's liability under no circumstances will exceed the contract price of goods claimed to be defective. Any returns under this guarantee are to be on a transportation charges prepaid basis. For products not manufactured by, but sold by ADB SAFEGATE, warranty is limited to that extended by the original manufacturer. This is ADB SAFEGATE's sole guarantee and warranty with respect to the goods; there are no express warranties or warranties of fitness for any particular purpose or any implied warranties of fitness for any particular purpose or any implied warranties other than those made expressly herein. All such warranties being expressly disclaimed.

Standard Products Guarantee

Products manufactured by ADB SAFEGATE are guaranteed against mechanical, electrical, and physical defects (excluding lamps) which may occur during proper and normal use for a period of two years from the date of ex-works delivery, and are guaranteed to be merchantable and fit for the ordinary purposes for which such products are made.



Note

See your sales order contract for a complete warranty description.

Replaced or repaired equipment under warranty falls into the warranty of the original delivery. No new warranty period is started for these replaced or repaired products.

FAA Certified products manufactured by ADB SAFEGATE

ADB SAFEGATE L858 Airfield Guidance Signs are warranted against mechanical and physical defects in design or manufacture for a period of 2 years from date of installation, per FAA AC 150/5345-44 (applicable edition).

ADB SAFEGATE LED products (with the exception of obstruction lighting) are warranted against electrical defects in design or manufacture of the LED or LED specific circuitry for a period of 4 years from date of installation, per FAA EB67 (applicable edition). These FAA certified constant current (series) powered LED products must be installed, interfaced and powered with and through products certified under the FAA Airfield Lighting Equipment Program (ALECP) to be included in this 4 (four) year warranty. This includes, but is not limited to, interface with products such as Base Cans, Isolation Transformers, Connectors, Wiring, and Constant Current Regulators.



Note

See your sales order contract for a complete warranty description.

Replaced or repaired equipment under warranty falls into the warranty of the original delivery. No new warranty period is started for these replaced or repaired products.

Liability



WARNING

Use of the equipment in ways other than described in the catalog leaflet and the manual may result in personal injury, death, or property and equipment damage. Use this equipment only as described in the manual.

ADB SAFEGATE cannot be held responsible for injuries or damages resulting from non-standard, unintended uses of its equipment. The equipment is designed and intended only for the purpose described in the manual. Uses not described in the manual are considered unintended uses and may result in serious personal injury, death or property damage.

Unintended uses, includes the following actions:

- Making changes to equipment that have not been recommended or described in this manual or using parts that are not genuine ADB SAFEGATE replacement parts or accessories.
- Failing to make sure that auxiliary equipment complies with approval agency requirements, local codes, and all applicable safety standards if not in contradiction with the general rules.
- Using materials or auxiliary equipment that are inappropriate or incompatible with your ADB SAFEGATE equipment.
- Allowing unskilled personnel to perform any task on or with the equipment.

© ADB SAFEGATE BV

This manual or parts thereof may not be reproduced, stored in a retrieval system, or transmitted, in any form or by any means, electronic, mechanical, photocopying, recording, nor otherwise, without ADB SAFEGATE BV's prior written consent.

This manual could contain technical inaccuracies or typographical errors. ADB SAFEGATE BV reserves the right to revise this manual from time to time in the contents thereof without obligation of ADB SAFEGATE BV to notify any person of such revision or change. Details and values given in this manual are average values and have been compiled with care. They are not binding, however, and ADB SAFEGATE BV disclaims any liability for damages or detriments suffered as a result of reliance on the information given herein or the use of products, processes or equipment to which this manual refers. No warranty is made that the use of the information or of the products, processes or equipment to which this manual refers will not infringe any third party's patents or rights. The information given does not release the buyer from making their own experiments and tests.

TABLE OF CONTENTS

1.0 Safety	1
1.1 Safety Messages	1
1.1.1 Introduction to Safety	2
1.1.2 Intended Use	2
1.1.3 Material Handling Precautions: Storage	3
1.1.4 Operation Safety	3
1.1.5 Maintenance Safety	3
1.1.6 Material Handling Precautions: Fasteners	4
1.1.7 Material Handling Precautions, ESD	4
2.0 About this Manual	5
2.1 How to work with the manual	5
2.2 Abbreviations and terms — AGL	5
2.3 Abbreviations and Terms	5
3.0 General Information	7
3.1 Introduction to RELIANCE	7
3.2 Taxiway Edge	8
4.0 Installation	11
4.1 Unpacking the Unit	11
4.2 Inspection upon delivery	11
4.3 Tools required	12
4.4 Torquing and Installation Guidance for In-pavement Fixtures	12
4.5 Installation and Removal of the 8-inch Light Fixture	12
4.6 Installation on a Shallow Base	13
4.7 RELIANCE Omni Base Assembly	14
4.8 Installation on L-868 Base	14
5.0 Operation	17
6.0 Maintenance	19
6.1 Safety instructions	19
6.2 Safety Considerations	19
6.3 Maintenance Schedule	19
6.4 Workshop Maintenance	20
6.4.1 Exploded View	21
6.4.2 Lifting Optical Unit From Base	23
6.4.3 Disassembling the Light Fixture	23
6.4.4 Cleaning the Lens	25
6.4.5 Testing a LED Assembly	25
6.4.6 Assembling a 8-inch Fixture	27
6.4.7 Closing and Testing Light Assembly	29
6.4.8 Replacing Lens and Flat Gasket	31
6.4.9 Replacing the Top Cover Assembly	34
6.4.10 Replacing the LED Board Assembly	36
6.4.11 Replace the Bottom Cover Assembly	39
6.4.12 Resetting the Fail-open Converter	40
6.4.13 Checking the Light Fixture for Water-tightness	40
7.0 Troubleshooting	43
8.0 Spare Parts	45
8.1 Ordering Code Taxiway Edge omnidirectional Light	45
8.2 Components	46
8.3 Screws Overview	46

9.0 INTEROPERABILITY	47
10.0 POWER TABLE	49
A.0 CABLE LOSS	51
B.0 SUPPORT	53
B.1 ADB SAFEGATE Website	53
B.2 Recycling	53
B.2.1 Local Authority Recycling	53
B.2.2 ADB SAFEGATE Recycling	54

List of Figures

Figure 1: RELIANCE Omni, 1 Dome	7
Figure 2: In an 8-in base	11
Figure 3: In a 12-in base with adapter ring	11
Figure 4: Example of a shallow base installation	14
Figure 5: Omnidirectional Light, 1 dome, 8-inch — Top cover assembly	21
Figure 6: Omnidirectional Light, 1-dome, 8-inch — Bottom cover assembly	22
Figure 7: Removing Pressure Release Screw	23
Figure 8: Disconnecting the LED cable from the optical assembly	24
Figure 9: Diode testing an LED assembly with a Fluke 87 Meter	26
Figure 10: Replacing Cover/Inner Cover O-ring Gasket	27
Figure 11: Orientation of the LED cable connector	28
Figure 12: Index Pin Hole Arrow	29
Figure 13: Index Pin of Inner Cover Flange	29
Figure 14: Flat gasket	31
Figure 15: LED Board Assembly and Protection Plate	32
Figure 16: Lens and Flat Gasket	33
Figure 17: Lens Gasket	34
Figure 18: Grease Application	34
Figure 19: LED board assembly (Optical assembly)	37
Figure 20: Optical Assembly Removal	38
Figure 21: LED Board connection	38
Figure 22: Bottom cover assembly and top cover assembly	39
Figure 23: Converter with 1 connector	40
Figure 24: Pressure Relief Screw	41
Figure 25: Pressure Test Fitting Assembly	41

List of Tables

Table 1: Preventive Maintenance	20
Table 2: Legend Exploded View — Part 1	21
Table 3: Legend Exploded View — Part 2	22
Table 4: Troubleshooting Procedures	43
Table 5: Interoperability matrix	47

1.0 Safety

Introduction to Safety

This section contains general safety instructions for installing and using ADB SAFEGATE equipment. Some safety instructions may not apply to the equipment in this manual. Task- and equipment-specific warnings are included in other sections of this manual where appropriate.

1.1 Safety Messages

HAZARD Icons used in the manual

For all HAZARD symbols in use, see the Safety section. All symbols must comply with ISO and ANSI standards.

Carefully read and observe all safety instructions in this manual, which alert you to safety hazards and conditions that may result in personal injury, death or property and equipment damage and are accompanied by the symbol shown below.



WARNING

Failure to observe a warning may result in personal injury, death or equipment damage.



DANGER - Risk of electrical shock or ARC FLASH

Disconnect equipment from line voltage. Failure to observe this warning may result in personal injury, death, or equipment damage. ARC Flash may cause blindness, severe burns or death.



WARNING - Wear personal protective equipment

Failure to observe may result in serious injury.



WARNING - Do not touch

Failure to observe this warning may result in personal injury, death, or equipment damage.



CAUTION

Failure to observe a caution may result in equipment damage.

Qualified Personnel



Important Information

The term **qualified personnel** is defined here as individuals who thoroughly understand the equipment and its safe operation, maintenance and repair. Qualified personnel are physically capable of performing the required tasks, familiar with all relevant safety rules and regulations and have been trained to safely install, operate, maintain and repair the equipment. It is the responsibility of the company operating this equipment to ensure that its personnel meet these requirements.

Always use required personal protective equipment (PPE) and follow safe electrical work practice.

1.1.1 Introduction to Safety



CAUTION

Unsafe Equipment Use

This equipment may contain electrostatic devices, hazardous voltages and sharp edges on components

- Read installation instructions in their entirety before starting installation.
- Become familiar with the general safety instructions in this section of the manual before installing, operating, maintaining or repairing this equipment.
- Read and carefully follow the instructions throughout this manual for performing specific tasks and working with specific equipment.
- Make this manual available to personnel installing, operating, maintaining or repairing this equipment.
- Follow all applicable safety procedures required by your company, industry standards and government or other regulatory agencies.
- Install all electrical connections to local code.
- Use only electrical wire of sufficient gauge and insulation to handle the rated current demand. All wiring must meet local codes.
- Route electrical wiring along a protected path. Make sure they will not be damaged by moving equipment.
- Protect components from damage, wear, and harsh environment conditions.
- Allow ample room for maintenance, panel accessibility, and cover removal.
- Protect equipment with safety devices as specified by applicable safety regulations
- If safety devices must be removed for installation, install them immediately after the work is completed and check them for proper functioning prior to returning power to the circuit.

Failure to follow this instruction can result in serious injury or equipment damage

Additional Reference Materials



Important Information

- IEC - International Standards and Conformity Assessment for all electrical, electronic and related technologies.
- IEC 60364 - Electrical Installations in Buildings.
- FAA Advisory: AC 150/5340-26 (current edition), Maintenance of Airport Visual Aid Facilities.
- Maintenance personnel must refer to the maintenance procedure described in the ICAO Airport Services Manual, Part 9.
- ANSI/NFPA 79, Electrical Standards for Metalworking Machine Tools.
- National and local electrical codes and standards.

1.1.2 Intended Use



CAUTION

Use this equipment as intended by the manufacturer

This equipment is designed to perform a specific function, do not use this equipment for other purposes

- Using this equipment in ways other than described in this manual may result in personal injury, death or property and equipment damage. Use this equipment only as described in this manual.

Failure to follow this instruction can result in serious injury or equipment damage

1.1.3 Material Handling Precautions: Storage



CAUTION

Improper Storage

Store this equipment properly

- If equipment is to be stored prior to installation, it must be protected from the weather and kept free of condensation and dust.

Failure to follow this instruction can result in equipment damage

1.1.4 Operation Safety



CAUTION

Improper Operation

Do Not Operate this equipment other than as specified by the manufacturer

- Only qualified personnel, physically capable of operating the equipment and with no impairments in their judgment or reaction times, should operate this equipment.
- Read all system component manuals before operating this equipment. A thorough understanding of system components and their operation will help you operate the system safely and efficiently.
- Before starting this equipment, check all safety interlocks, fire-detection systems, and protective devices such as panels and covers. Make sure all devices are fully functional. Do not operate the system if these devices are not working properly. Do not deactivate or bypass automatic safety interlocks or locked-out electrical disconnects or pneumatic valves.
- Protect equipment with safety devices as specified by applicable safety regulations.
- If safety devices must be removed for installation, install them immediately after the work is completed and check them for proper functioning.
- Route electrical wiring along a protected path. Make sure they will not be damaged by moving equipment.
- Never operate equipment with a known malfunction.
- Do not attempt to operate or service electrical equipment if standing water is present.
- Use this equipment only in the environments for which it is rated. Do not operate this equipment in humid, flammable, or explosive environments unless it has been rated for safe operation in these environments.
- Never touch exposed electrical connections on equipment while the power is ON.

Failure to follow these instructions can result in equipment damage

1.1.5 Maintenance Safety



DANGER

Electric Shock Hazard

This equipment may contain electrostatic devices

- Do not operate a system that contains malfunctioning components. If a component malfunctions, turn the system OFF immediately.
- Disconnect and lock out electrical power.
- Allow only qualified personnel to make repairs. Repair or replace the malfunctioning component according to instructions provided in its manual.

Failure to follow these instructions can result in death or equipment damage

1.1.6 Material Handling Precautions: Fasteners



DANGER

Foreign Object Damage - FOD

This equipment may contain fasteners that may come loose - torque properly.

- Only use fasteners of the same type as the one originally supplied with the equipment.
- Use of incorrect combination of gaskets, bolts and nuts can create severe damages to the product installation and create safety risk .
- You need to know what base the light fixture will be installed in, in order to chose the correct gasket, bolts and nuts.
- Bolt type, length, and torque value are determined by type of base, height of spacers used, and clamp force required in FAA Engineering Brief No 83 (latest revision).
- Due to the risk of bolts vibrating loose, do not use any type of washer with the fixing bolts (such as split lock washers) other than an anti-vibration washer. Anti-vibration washers as defined in FAA EB 83 (latest edition) must be used. For installations other than FAA, use the base can manufacturer's recommendations.
- Always tighten the fasteners to the recommended torque. Use a calibrated torque wrench and apply the recommended adhesive type.
- Obey the instructions of the adhesives necessary for the fasteners.

Failure to follow these warnings may cause the fasteners to loosen, damage the equipment, potentially to loosen the equipment. This can lead to a highly dangerous situation of FOD, with potential lethal consequences.



Note

To minimize the risk of errors, the ADB SAFEGATE Sales Representative will have information on which gasket goes with which base. This information is also provided in the product Data sheets, the User Manuals and the Spare Part Lists.



CAUTION

Use of incorrect combination of gaskets, bolts and nuts can create severe damages to the product installation and create multiple safety risks.

To obtain a safe and watertight installation the O-ring and retaining bolt stated in the document must be used.

You need to know what base the light fixture will be installed in, in order to choose the correct gasket, bolts and nuts.

Failure to follow these cautions can result in equipment damage or aircraft FOD.

1.1.7 Material Handling Precautions, ESD



CAUTION

Electrostatic Sensitive Devices

This equipment may contain electrostatic devices

- Protect from electrostatic discharge.
- Electronic modules and components should be touched only when this is unavoidable e.g. soldering, replacement.
- Before touching any component of the cabinet you shall bring your body to the same potential as the cabinet by touching a conductive earthed part of the cabinet.
- Electronic modules or components must not be brought in contact with highly insulating materials such as plastic sheets, synthetic fiber clothing. They must be laid down on conductive surfaces.
- The tip of the soldering iron must be grounded.
- Electronic modules and components must be stored and transported in conductive packing.

Failure to follow this instruction can result in equipment damage

2.0 About this Manual

This document includes information on the RELIANCE omnidirectional 8-inch inset light fixture with a focus on safety, installation and maintenance procedures.

For more information, see www.adbsafegate.com.



Note

It is very important to read this document before any work is started.

2.1 How to work with the manual

1. Become familiar with the structure and content.
2. Carry out the actions completely and in the given sequence.

2.2 Abbreviations and terms — AGL

Abbreviations and terms	Description
FAA	Federal Aviation Administration
ICAO	International Civil Aviation Organization
IEC	International Electrical Committee
ISO	International Standardization Organization
ANSI	American National Standards Institute
NFPA	National Fire Protection Association
AC	Advisory Circular (FAA)
ESD	Electro-Static Discharge; Electrostatic-Sensitive Devices
LED	Light Emitting Diode
PPE	Personal Protective Equipment
FOD	Foreign Object Debris
Mounting support	A piece of equipment, on which the fixture is installed.
Toe-in	The toe-in angle is the angle the beam of light makes with the longitudinal axis of the runway or taxiway.

2.3 Abbreviations and Terms

This document may include the abbreviations and terms listed below.

Abbreviation and term	Description
A-SMGCS	Advanced Surface Movement Guidance and Control System
CAA	Civil Aviation Authority
CCR	Constant Current Regulator
FAA	Federal Aviation Administration
ICAO	International Civil Aviation Organization
IEC	International Electrotechnical Committee
ILCMS	Individual Light Control and Monitoring System

Abbreviation and term	Description
LED	Light Emitting Diode
NATO	North Atlantic Treaty Organization
SMGCS	Surface Movement Guidance and Control System
SSU	System Switch Unit
STAC	Service Technique de l'Aviation Civile (France)
STANAG	Standardization Agreement (NATO)

3.0 General Information



WARNING

Read installation instructions in their entirety before starting installation.

- Become familiar with the general safety instructions in this section of the manual before installing, operating, maintaining or repairing this equipment.
- Read and carefully follow the instructions throughout this manual for performing specific tasks and working with specific equipment.
- these warnings may result in serious injury or equipment damage.

Figure 1: RELIANCE Omni, 1 Dome



3.1 Introduction to RELIANCE

RELIANCE - the all in one revolution

The RELIANCE omnidirectional light fixture is a low protrusion light-emitting diode (LED) fixture, available in three versions:

RELIANCE NON-MON	A LED light fixture without monitoring (No CCR monitoring or ILCMS compatibility)
RELIANCE MON	A LED light fixture with integrated fail open technology with CCR monitoring compatibility
RELIANCE IQ	A RELIANCE with additional and integrated intelligence (IQ) in a built-in converter for individual monitoring and control, based on RELIANCE Intelligent Light Control and Monitor System (ILCMS)
RELIANCE IQ0	RELIANCE IQ light fixture with disabled IQ (ILCMS) functionality. Non-MON light fixture with possibility to activate IQ at a later stage

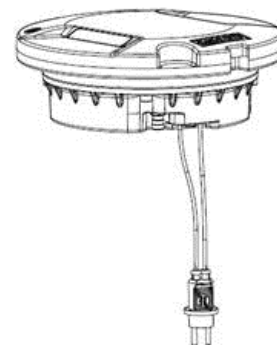



NOTICE

RELIANCE IQ light fixtures are not fail-open light fixtures. When IQ is activated the monitoring as well as the control functionality is handled by the ILCMS system.

3.2 Taxiway Edge

Compliance with Standards (current versions)

FAA	L-852T(L)
ICAO	Annex 14, Volume 1
IEC	61827
EASA	CS-ADR-DSN
Canada	TP 312
Australia	MOS 139

CE

Uses

The RELIANCE™ 8-inch omnidirectional low-protrusion inset LED light fixture is provided with blue or yellow LEDs. This fixture can be used in the following applications:

- ICAO Taxiway Taxiway Edge, FAA L-852T(L)
- Intermediate Holding Position (MOS)

Features and Benefits

- Efficiency**
- RELIANCE IQ with integrated intelligence
 - RELIANCE with integrated fail-open technology
 - Operates on 3- or 5-step ferroresonant or thyristor CCRs designed in compliance with IEC or FAA requirements
 - Easy maintenance due to modular design, few mechanical parts
- Sustainability**
- Light-emitting diode (LED) technology that offers a long-lasting light source with low power consumption
 - IP68 protected (all fastenings in stainless steel)
 - Compatible with existing infrastructure
 - Fixture compatible with all ADB SAFEGATE 8-inch bases
- Safety**
- Failed LED detection according to FAA Engineering Brief No.67D

Power Supply

An integrated, encapsulated 6.6A electronic converter. Two-pole L-823 FAA Style 6 (2-pin-) plug for connection to the transformer. Power factor typically >0.95 at 6.6 A.

French (flat 3-pin) plugs are also available for the French market. Please check ordering code.

Maintenance and Installation

Refer to the RELIANCE user manual of the RELIANCE 8-inch 1-dome omni light and to the interoperability info for installation in a specific base.

Dimensions and Weight

Outer diameter / depth	Approx. 203 mm / 81.35 mm
	8 in / 3.2 in
Weight without packaging	Approx. 3.4 kg
	7.5 lb

Operating Conditions

Operating temperature	-60 °C to +55 °C / -76 °F to +131 °F
Storage temperature	-60 °C to +80 °C / -76 °F to +176 °F
Relative humidity	Up to 100%

Note

- Digit 3-4 of the ordering code: TE includes MOS Intermediate Holding Position.
- Deep base and / or adapter rings to be ordered separately.

For more information about the product, including manuals and certifications, please see our Product Center on the ADB SAFEGATE website: www.adbsafegate.com.

4.0 Installation

Install the inset light fixture in a base provided by ADB SAFEGATE as follows:

Figure 2: In an 8-in base

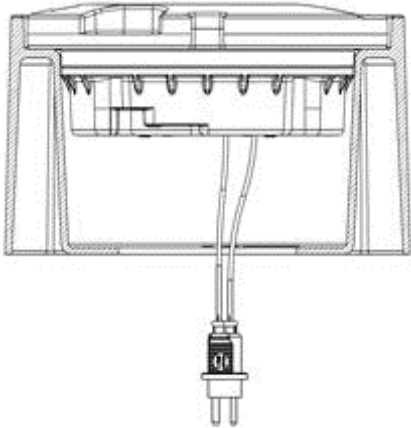
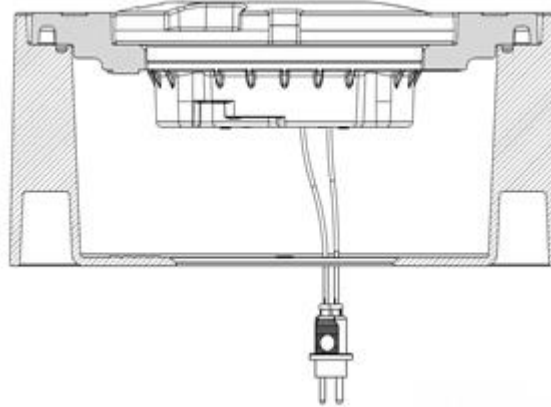

Figure 3: In a 12-in base with adapter ring



Note

If the inset light fixture is to be installed on another type of base or adapter ring not provided by ADB SAFEGATE, contact ADB SAFEGATE. The inset light fixture is fixed in the base by six M10 lock nuts or by six M10×25 or M10×22 bolts dependent on base installation.



CAUTION

Use of incorrect combination of gaskets, bolts and nuts can create severe damages to the product installation and create multiple safety risks.

To obtain a safe and watertight installation the O-ring and retaining bolt stated in the document must be used.

You need to know what base the light fixture will be installed in, in order to choose the correct gasket, bolts and nuts.

4.1 Unpacking the Unit

To reduce the possibility of damaging the light assembly, unpack the RELIANCE light fixtures at the installation site. If damage to any equipment is noted, file a claim form with the carrier immediately.

When receiving the light fixture, open the box and verify that the characteristics of the light fixture correspond to the design requirements, such as type, color etc. When installing an IQ0 light fixture where the function is to be activated at a later stage, make sure to register product information, such as PID/SN and position of the light fixture in, for example, a site documentation table. The information is required for remote activation and administration of IQ functionality from a substation.

4.2 Inspection upon delivery

1. Inspect all packing for visible damage.
2. Open every damaged box and inspect the contents for damage.
3. Immediately fill a claim form with the carrier if any fixture is damaged.
4. Store the fixture in its original packing in a protected area.

Note

If damage to any equipment is noted, file a claim form with the carrier immediately.



WARNING

Do not damage the cable insulation.



CAUTION

Do not unpack the fixture before it is at the installation site to avoid damage due to transportation and handling.

4.3 Tools required

The following tools are recommended for installation.

- One Box spanner 16/17 mm
 - One torque wrench with a 16/17 mm socket
 - Two large flat headed screwdrivers for lifting the light fixture
 - One T20 Torx key
 - One brush or cloth
 - One 3 mm Allen key
-



Note

Provided that the base intended to receive the light fixture has been properly installed, no other specific tool is required.

4.4 Torquing and Installation Guidance for In-pavement Fixtures

In-pavement fixtures must be installed according to the plans and specifications; the applicable regulatory guidance; and the following guidance. The importance of using the proper fixture clamping components and bolt torque to minimize the risk for fixture failure or loosening of clamping components cannot be overemphasized. Refer to FAA Engineering Brief No 83 (latest revision) for torque and installation guidelines for this fixture.

Also see our Product Center at www.adbsafegate.com.



CAUTION

Read installation instructions in their entirety before starting installation.

- Failure to follow the installation guidance could result in bolt loosening or bolts breaking off, resulting in catastrophic failure of the fixture and/or the mounting system components.
 - Failure to follow these warnings may result in serious injury or equipment damage.
-

4.5 Installation and Removal of the 8-inch Light Fixture

Installing the light fixture in a base

Installation instructions for the inset light fixtures as follows:

- Light bases shall be installed with care to assure vertical and azimuth alignment of fixture.
 - Provide 60–90 cm / 2–3-foot cable slack within light base to allow transformer servicing.
-

- The minimum thread engagement into top flange of base is 12,7 mm (0.5 inch).
 - As required to maintain +0/ through -1/16-inch below grade FAA installation tolerance, a maximum of three spacer rings may be stacked together.
1. Carefully clean all contact surfaces of the light fixture and the base.
 2. Put the correct gasket (O-ring or labyrinth gasket) on the inner cover of the light. Refer to the [INTEROPERABILITY](#) appendix for this fixture.
 3. Connect the connector of the light fixture to the base supply cable.
 4. Place the connector under the light fixture and install on the base.
 5. For an installation on bases, use a torque limiting box spanner of 16/17 mm, install and tighten the two fixing bolts or nuts to a torque value according to specification, refer to [INTEROPERABILITY](#) appendix. For other base manufacturers, refer to their specifications.

Restriction

Do not use high speed for tightening, the recommended speed is 10 - 40 rpm.

6. After installation, check that each light fixture functions properly.
7. In order to bond the light fixture to ground, use the supplied screw (Torx M4×6 mm, Torque 2.5 Nm) to attach the braided ground strap to the grounding point on the light fixture. The grounding point is indicated by a grounding symbol and located on the bottom side.

Removing the fitting from the base



CAUTION

Fall- and trip hazard! When a light fixture has been removed, the base must be fitted with a cover designed for this purpose or with a spare light fixture.

1. Remove the light fixture from the base using two large flat blade screwdrivers.
2. Disconnect the secondary supply connector.
3. Remove and check the gasket (O-ring or labyrinth).



Note

It is recommended to change the gasket, lock nuts or bolts each time the light fixture is removed or dismantled from the base. For more information, refer to [INTEROPERABILITY](#) appendix.



CAUTION

Use of incorrect combination of gaskets, bolts and nuts can create severe damages to the product installation and create multiple safety risks.

Make sure to know what base the light fixture will be installed in, in order to choose the correct gasket, bolts and nuts.

Failure to follow these cautions can result in equipment damage or aircraft FOD. For more information, see [INTEROPERABILITY](#).

4.6 Installation on a Shallow Base

Installing the RELIANCE omnidirectional light fixture on a shallow base involves preparing the pavement recess and wire ways, then installing the light fixture on a shallow base.



Note

Refer to [RELIANCE Omni Base Assembly](#) section for additional details on the optional shallow base supplied with the RELIANCE omni fixture.

Remember

Refer to FAA AC 150/5345-30 and the project site-specific plans and specifications for details on shallow base installation.

Also follow the applicable instructions in the previous section, [Installation on L-868 Base](#) section when connecting, installing and powering the fixture.

Figure 4: Example of a shallow base installation

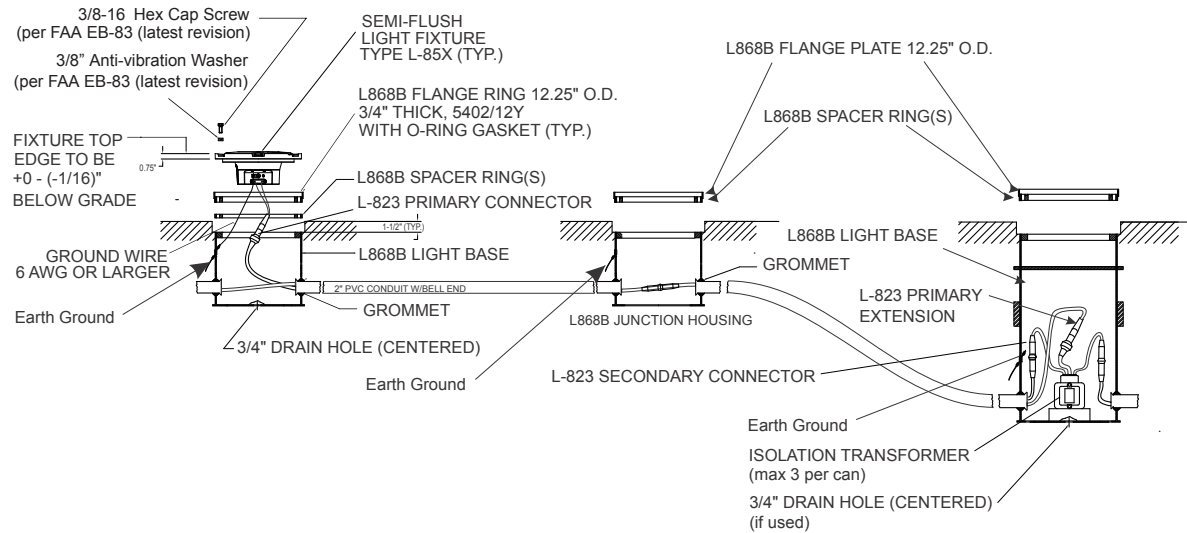

4.7 RELIANCE Omni Base Assembly

The optional shallow base is shipped separately from the Omni fixture.

The shallow base is a 12-inch O.D. L-868B base can and includes connectors to attach to the external wiring. Contact the ADB SAFEGATE Sales Department for additional information.

4.8 Installation on L-868 Base

The light assembly is shipped complete, and is ready for installation.

To install the fixture on an L-868 base, see FAA AC 150/5345-30 and the project site-specific plans and specifications for details on L-868 base installation.



Note

Mounting bolts are not supplied with the fixture. Mounting bolts and anti-rotation lock washers are normally supplied with the base can spacer or flange ring. If a flange ring is used, the bolt length is 1-1/4 inch (32mm) plus the thickness of the flange ring.

Also read the following guidelines:

1. Clean the base receptacle. Make sure the base receptacle is completely clean and dry. The mating surfaces must be clean and free of foreign particles.
2. If, present, fit an appropriate lifting tool into the two threaded holes, which are located 180° apart in the cover.



The lifting tool can be made from two 1/2 x 13 eyebolts (1-inch ID) and a 1/2-inch diameter, 16-inch (406mm) long rod or pipe inserted through the eyebolts.

Important

Never hold the light fixture by the wires. Doing so may damage the insulation, break the waterproof seal and cause insulation faults and water leakage.

3. Carry the light assembly to the base.
4. Place the light assembly next to the opening in the L-868 base so that the L-823 connector can be connected with the mating receptacle from the L-830 or L-831 isolation transformer in the base. Make sure that the connection is solid and secure. Refer to the Electrical Supply section of the User manual for required isolation transformers.
5. Make sure items such as spacers, shims and gaskets are installed on the light base as indicated on site plans, specifications and drawings.
6. Position the light assembly over the L-868 base and set it onto the base. Align the light according to FAA AC 150/5345-30 and project plans and specifications. Remove the eyebolts and lifting rod.

Important

Ensure that the cord set wires are NOT pinched between the base can and the fixture. Pinched wires can cause water to be drawn inside the fixture.

7. If present, lubricate the labyrinth gasket with water. soap may be added to the water (8-inch only).



NOTICE

Do not use silicon or any other type of grease. Avoid the use of soap that contains silicon or glycerin.

8. Attach the six fixing bolts and anti-vibration washers. [See FAA EB-83 (latest revision)]



NOTICE

Due to the risk of bolts vibrating loose, do not use any type of washer with the fixing bolts (such as split lock washers) other than an anti-vibration washer. Anti-vibration washers as defined in FAA EB-83 (latest revision).

9. Turn on the power to determine whether the LED fixture will illuminate. Operate for a minimum of five minutes.

5.0 Operation



NOTICE

Refer to the RELIANCE Intelligent Lighting user documentation if you are using an IQ light fixture.

6.0 Maintenance

This section describes different steps for maintenance of the Omni 1 dome 8-inch light fixture.

6.1 Safety instructions



CAUTION

Electric Shock Hazard

Prior to the commencement of work all electrical services MUST be isolated from the supply and connected to earth. Full details of the work involved must be given to the authorized Person responsible for the electrical engineering services at the airport with regard to the duration of the work and so on. It is recommended that prior to starting any cutting work the nature and location of services such as cable ducts and so on, should be identified Any installation or maintenance work should only be carried out by trained and experienced personnel.



CAUTION

High Light intensity!

Do not stare directly into the light beam at a close distance.

6.2 Safety Considerations

Read the installation section of all system component manuals before starting these steps. A thorough understanding of system components and their requirements will promote safe and efficient installation. See FAA AC 150/5340-30, Design and Installation Details for Airport Visual Aids, and site plans and specifications for field installation of runway and taxiway in-pavement lights.



DANGER

Failure to follow these safety procedures can result in personal injury or death.

- Allow only qualified personnel to install ADB SAFEGATE and auxiliary equipment. Use only approved equipment. Using unapproved equipment in an approved system may void FAA approvals. Observe and follow the safety instructions in this document and all other related documentation.
- Make sure all equipment is rated and approved for the environment where it is being used.
- Follow all instructions for installing components and accessories.
- Install all electrical connections in compliance with local and national codes and regulations.
- Use only electrical wire of sufficient gauge and insulation to handle the rated current demand. All wiring must meet local and national codes.
- Route electrical wiring along a protected path. Make sure it will not be damaged by moving equipment.
- Protect components from damage, wear and harsh environmental conditions.
- Allow ample clearance for maintenance, panel accessibility and cover removal.
- Protect equipment with safety devices as specified by applicable safety regulations.
- If safety devices must be removed for installation, reinstall them immediately after the work is completed and check them for proper functioning.
- The cord set must be protected prior to installation.

6.3 Maintenance Schedule

Service life depends upon the entire assembly being waterproof. All surfaces must be clean, dry and free of all foreign matter and all bolts must be properly tightened if the light fixture is to operate for extended periods without requiring maintenance.

To keep the light fixtures operating efficiently, follow a preventive maintenance schedule. Refer to [Table 1](#). Refer to FAA AC 150/5340-26 for more detailed information.

Table 1: Preventive Maintenance

Interval	Check	Corrective Action
Daily	Low light output	Clean outer surface of prism if dirty. Refer to <i>Cleaning Light Channel and Lens</i> this section. Check for presence of moisture in fixture.
Weekly	For obstruction in light output channel	Clean the optical surface. Refer to Cleaning the Lens this section.
Monthly (or more frequently during rainy seasons)	For presence of moisture or water (visual inspection for condensation on inner side of prisms)	Open up light assembly. Clean, dry, and inspect light assembly. Replace cover/inner cover gasket and other parts found defective. Replace LED assembly. Refer to Replacing LED Assembly .
Bimonthly	Torque on hold-down bolts	Torque two bolts holding fixture to base. Refer to <i>Torquing Mounting Bolts</i> in this section. Refer also to <i>Installation on L-828B Base</i> in the <i>Installation</i> section.
Semi-annually (or more frequently during rainy seasons)	Check the base for water ingress	Remove water from base. Remove and inspect light for water damage.
After snow removal	For damaged light fixtures	Replace damaged fixtures. Use a power broom for snow removal, if practical.

6.4 Workshop Maintenance

Remember

Before you start, make sure you have read and understand [Safety instructions](#).

Important

Make sure you check the fixture for watertightness very time you replaced a spare part!

The following standard tools and accessories are required for maintenance of the unit:

- One angled socket spanner of 16 or 17 mm ¹
- One torque limiting spanner with 16 or 17 mm socket ¹
- Torx screw driver 10, 20, 25, and 30 mm
- Two large flat blade screwdrivers
- CC-Patron grease
- One brush or cloth
- Non-alcohol based cleaner
- Water-tightness tool



NOTICE

A compressor, or a manual car tire pump, equipped with a manometer is required to check the light fixture for water-tightness.

Design may differ from picture depending on application. Please follow described work flow and torque level specified as they are generic.

¹ Depending on type and size of nuts and bolts

6.4.1 Exploded View

Figure 5: Omnidirectional Light, 1 dome, 8-inch — Top cover assembly

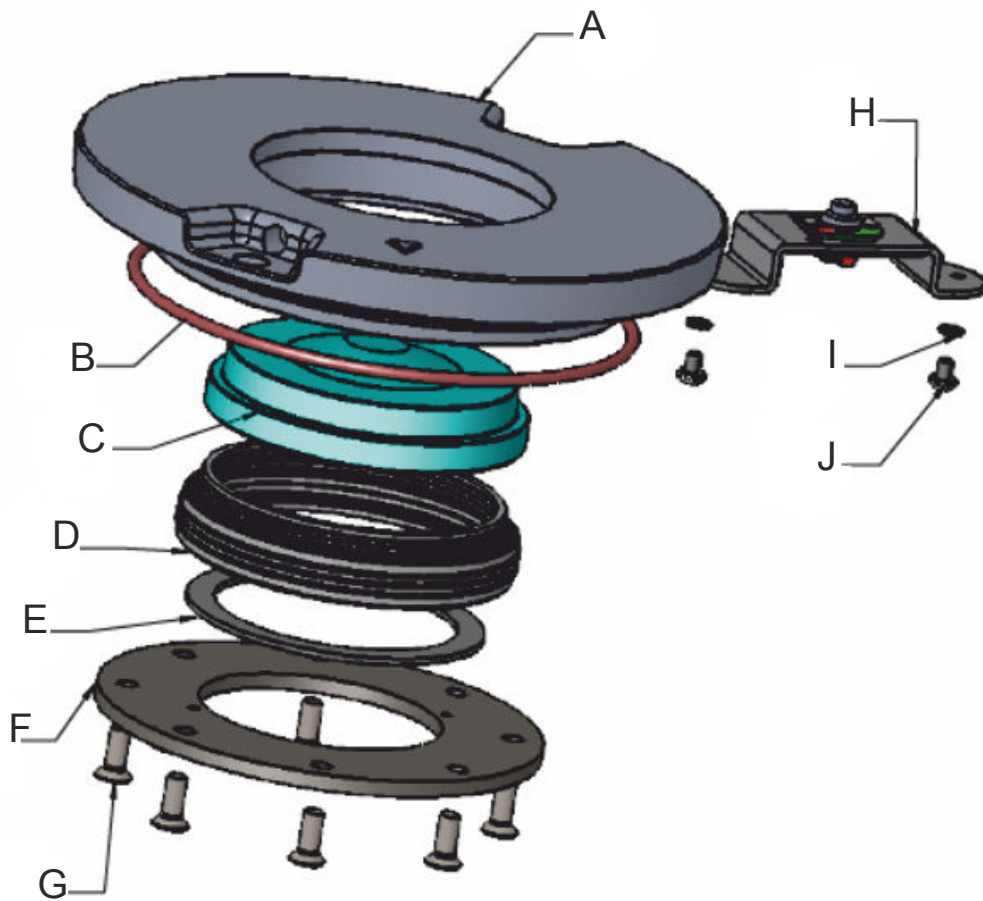

Table 2: Legend Exploded View — Part 1

Callout number	Description	Quantity
A	Top cover assembly	1 pc
B	O-ring	1 pc
C	Lens	1 pc
D	Lens gasket	1 pc
E	Flat gasket	1 pc
F	Protection plate	1 pcs
G	Screw M6x16	8 pc
H	Optical assembly	1 pc
I	Lockwasher M4	2 pcs
J	Screw M4x6	2 pcs

Figure 6: Omnidirectional Light, 1-dome, 8-inch — Bottom cover assembly

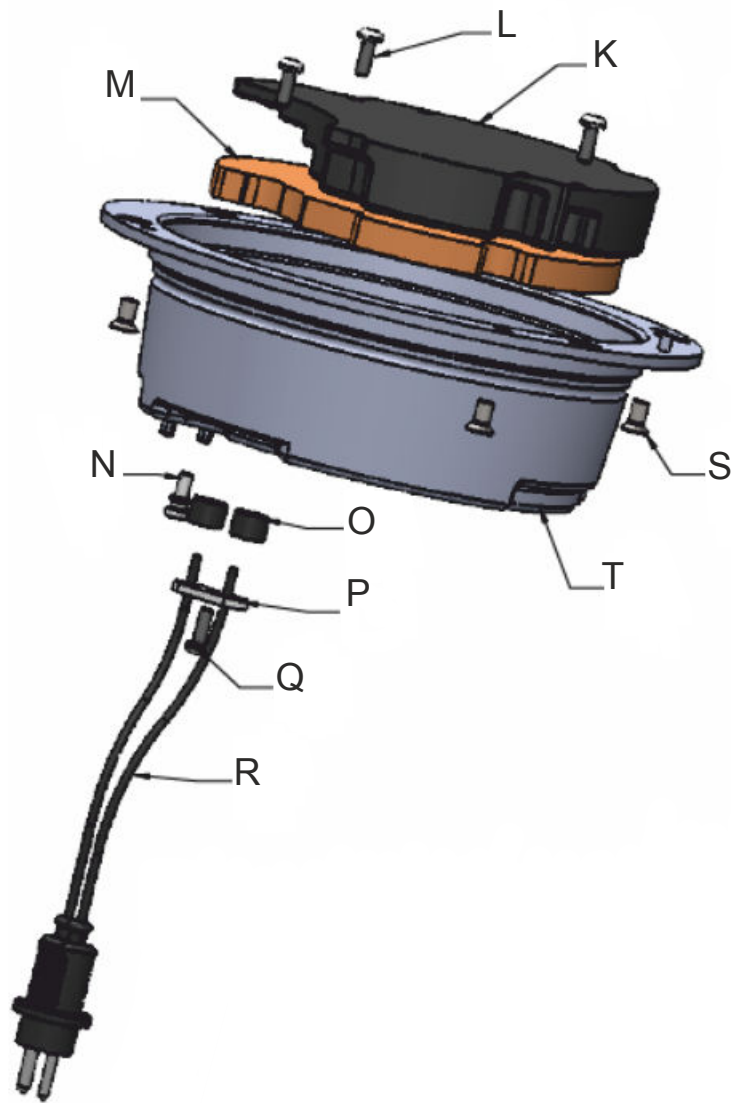

Table 3: Legend Exploded View — Part 2

Callout number	Description	Quantity
K	Converter	1 pc
L	Screw M4x12 + Loctite 2045	4 pcs
M	Cooling pad	1 pc
N	Pressure release screw	1 pc
O	Cable gland gasket	2 pcs
P	Cable gland disc	1 pc
Q	Screw M4x12 + Loctite 2045	4 pcs
R	FAA cable style 6, 600mm	1 pc
S	Screw M5x10 + Loctite 2045	4 pcs
T	Inner cover 2W1C	1 pc

6.4.2 Lifting Optical Unit From Base

To lift the optical unit from the light base, perform the following procedure:

1. Remove both fixing screws and washers or self locking nuts.
2. Fit the appropriate lifting tool into both holes located (180° apart) in the cover, lift the optical unit out of the base and place the optical unit next to the base.
3. Disconnect the light fixture wires from the power wires coming from the transformer.
4. Mount a serviced or new light fixture.



CAUTION

Never hold the light fixture by the wires. This may damage the insulation, break the waterproof seal, and cause insulation faults and water leakage.

Failure to follow this instruction can result in equipment damage.

5. Take the inset fixture unit back to the maintenance shop where it can be serviced entirely.

6.4.3 Disassembling the Light Fixture

To open the optical assembly, perform the following procedure:

1. Turn the light unit upside-down.
2. See [Figure 7](#).

Remove the pressure release screw (2). This relieves any built-up internal pressure and makes it easier to remove the inner cover.

Figure 7: Removing Pressure Release Screw

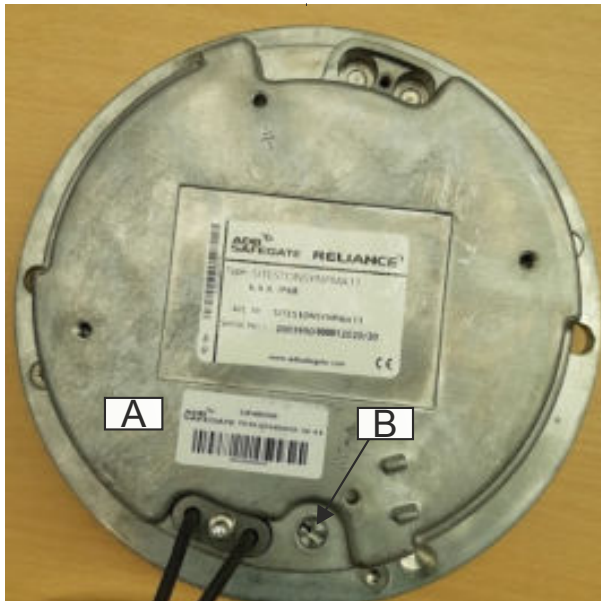

A = Inner Cover Assembly

B = Pressure Release Screw

3. Remove the four torx head screws that fasten the inner cover to the top cover.
The use of an impact driver may be required to unlock the screws.
4. Carefully lift off the inner pan from the cover, taking care not to damage the wire connection between the main PCB and the LED assembly.



Note

If the inner pan does not separate from the cover assembly easily, use a flat bladed screwdriver to separate it by inserting the screwdriver blade in the pry slots. There are 2 slots 180 degrees apart milled into the underside flange of the top cover that mates with the inner cover flange.



CAUTION

Be careful. Do not pull on the LED lead cable when you lift the inner pan. This may damage the connection!
Failure to follow this instruction can result in equipment damage.

5. Refer to [Figure 8](#).

Disconnect the LED cable.



NOTICE

Do not pull the cable out, but carefully disconnect the LED cable by lifting the connector straight up. If not done correctly there is a risk to damage the PCB or cable connector.

Figure 8: Disconnecting the LED cable from the optical assembly

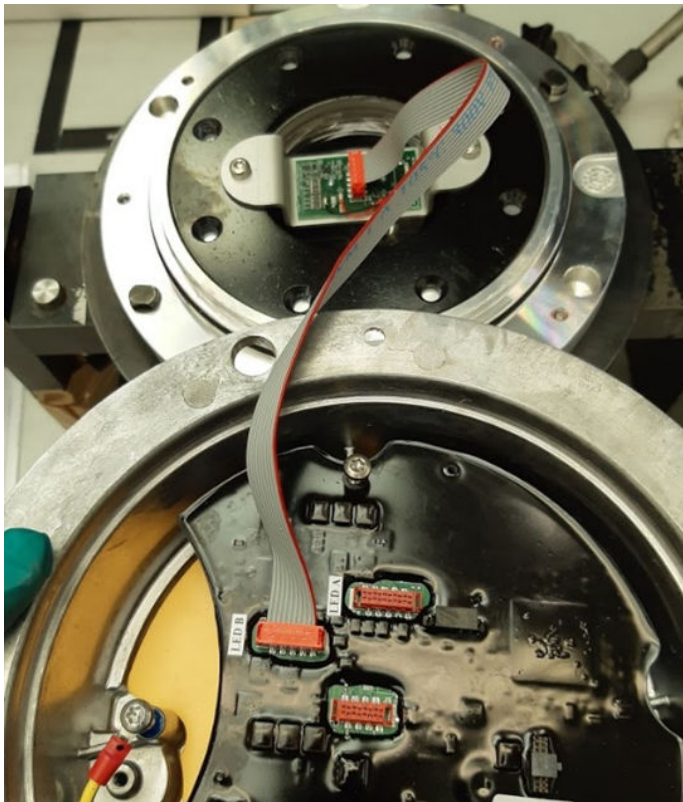

6. Remove the inner pan from the cover. Discard the old O-ring.



Note

Always replace the cover/inner cover O-Ring seal Item whenever the inset fixture is opened. This guarantees light fixture water tightness.

6.4.4 Cleaning the Lens

To clean the prism, perform the following procedure:

1. Clean the outer surface of the lens using liquid glass cleaner.
If the prism is coated with a substance impervious to the cleaner, apply a suitable solvent sparingly with a wad of cotton or a patch of cloth.
2. After the solvent has acted, remove the softened coating with a clean piece of cotton or cloth.
3. Dry the prism with gently, dry, oil-free compressed air at a pressure no greater than 10 psi (0.69 bar) to evaporate or remove all remaining cleaner.

6.4.5 Testing a LED Assembly

For this test, use a Fluke 87 or equivalent meter.



CAUTION

Do not use the megger function or a resistive test of any meter on an LED assembly! This may damage the LED's properties required for proper operation.

A "Diode Test" function may be used as a quick pass/fail check on an LED. In the maintenance shop, open the fixture and unplug the LED assembly.

1. Set the meter to test a DIODE.
2. Connect the meter leads to the LED assembly.
Observe if the LED glow and also note the meter reading of the LED.
3. Then reverse the meter leads and observe the LED again.



Note

With good LEDs when forward biased, the LEDs will glow dimly and the meter will indicate a low resistance. When the LEDs are reverse biased, the LEDs will not glow and the meter will indicate a high resistance.

4. Test a known, good LED assembly in the same manner to verify your meter's operation and typical meter indications.

Figure 9: Diode testing an LED assembly with a Fluke 87 Meter

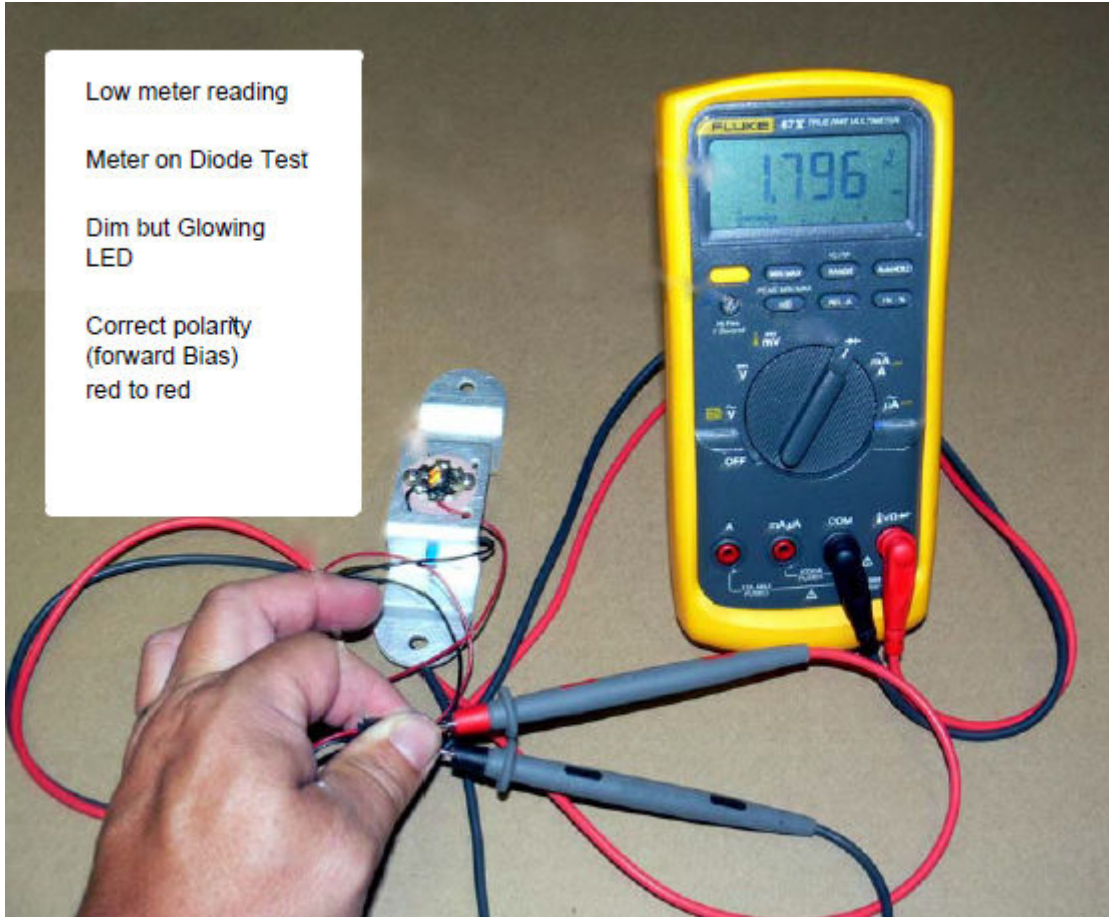

6.4.6 Assembling a 8-inch Fixture

Replacement

1. Carefully clean all contact surfaces of the light fixture and of the housing.
2. Install a new O-ring gasket on the bottom cover.

Figure 10: Replacing Cover/Inner Cover O-ring Gasket

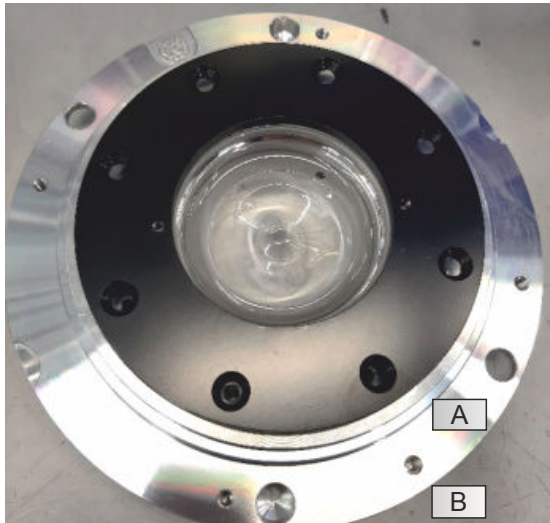

A = O-Ring seal

B = Screw Driver Pry Slot

Important

The O-ring gasket must be changed each time the light fixture is disassembled.

3. Connect LED assembly with converter by pressing connector on.

Important

Make sure that the cable is correctly installed according to the pictures below. Refer to [Figure 11](#).

- a) Connect the LED board cable. Note the orientation and alignment of the cable. Connect the LED board cable connector to the Supply Terminal of the converter in the housing. Note the orientation and alignment of the LED board cables.



Note

Before closing the light fixture, it is important to make sure the O-ring is placed correctly in the groove of the bottom cover to prepare the light fixture for water tightness checks and use in the airfield. For more information, refer to [Figure 21](#).



NOTICE

Make sure that the LED cable is connected to the LED B-channel.

- b) Place the top cover over the bottom cover, align A and B sides on the top cover with the corresponding sides on the bottom cover.



NOTICE

Make sure you connect the LED cable connector in the right sense (pay attention to orientation of the red side). If incorrectly connected there is a risk to damage connector and converter. Refer to [Figure 11](#).

Figure 11: Orientation of the LED cable connector

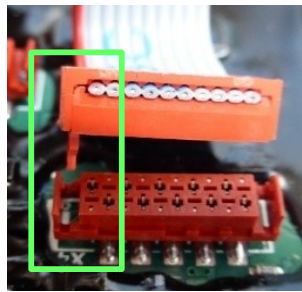
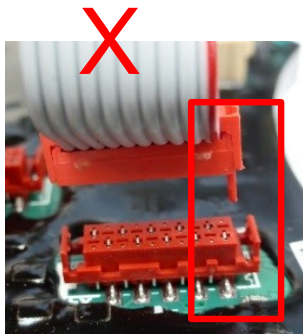
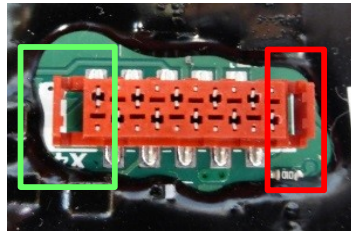
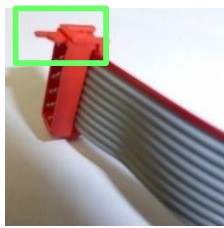
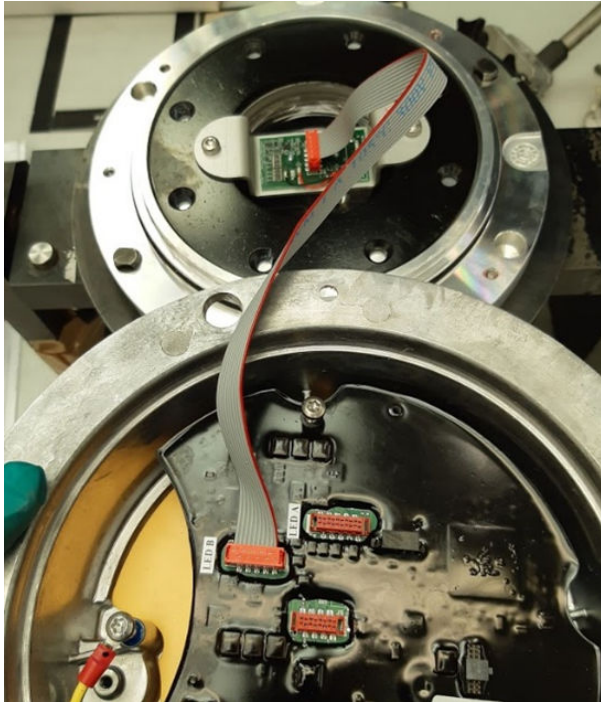

4. Place the top cover over the bottom cover.

Important

Before closing the light fixture, it is important to make sure the O-ring gasket is placed correctly in the groove of the bottom cover to prepare the light fixture for water tightness checks and use in the airfield.

5. Put the light fixture on a surface with the top cover facing down.

6. Apply one drop of Loctite 234 and tighten the four M5x10 screws crosswise using a torx key set to 3.5 mm to a torque of 3.5 Nm.
7. Check the light fixture for water-tightness.



Note

Refer to [Checking the Light Fixture for Water-tightness](#) section for more information.

6.4.7 Closing and Testing Light Assembly

To close and test the light assembly, perform the following procedure:



CAUTION

Misalignment of the index pin in the inner cover flange and its mating hole in the underside of the top cover and will prevent components from being assembled correctly. Damage may also occur to the top cover and inner cover. Failure to follow this instruction can result in equipment damage.

1. See [Figure 12](#).

Turn the cover over and find the arrow cast into the top of the cover. This arrow indicates the location of the index pin hole that is machined into the underside area of the top cover.

2. See [Figure 13](#).

Find index pin molded into the flange of the inner cover. The index pin needs to align with its mating hole found on the underside of the top cover.

Figure 12: Index Pin Hole Arrow

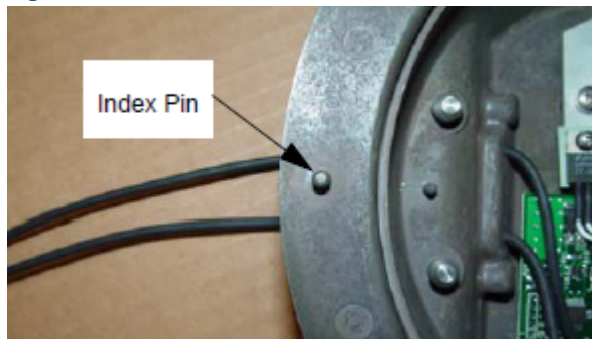

Figure 13: Index Pin of Inner Cover Flange



3. Put the top cover over the inner cover and align the index pin on the inner cover flange with the index arrow on the top cover
4. Gently put the inner cover on top of the cover ([Figure 12](#)), taking into account the index pin between both parts. Make sure that LED leads do not get damaged when the top cover is installed on the inner cover.
5. Press the inner cover on the cover and secure with new torx head screws with washers.

Refer to [Replacing Lens and Flat Gasket](#) section.

6. Check the electrical insulation from two-pole plug to frame by means of a 500 V insulation tester.

Apply an AC current not exceeding 6.6 A on the two-pole plug and observe normal operation of the LED.



CAUTION

The electronic circuit is designed to be fed from a regulated AC constant current generator only, for example, a constant current regulator. Do not use a voltage generator as this might damage the electronic components or fail to energize the light.

Failure to follow this instruction can result in equipment damage.



Note

Refer to [Checking the Light Fixture for Water-tightness](#) section for instructions on testing.

6.4.8 Replacing Lens and Flat Gasket

1. Disassemble the light assembly.
Refer to [Disassembling the Light Fixture](#) section.
2. Unscrew the eight M6 metric torx cap screws and then remove the assembled LED bracket and LED support plate.

Figure 14: Flat gasket

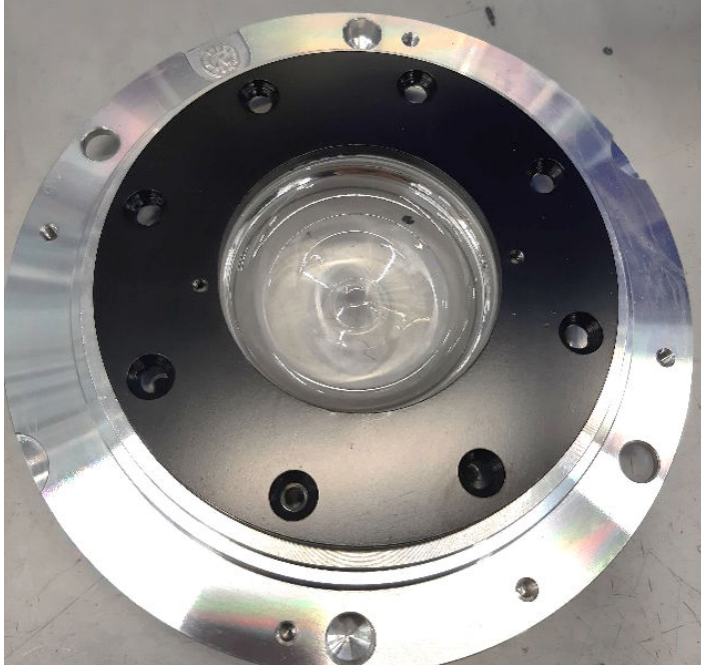

Note

The two M6 torx Cap Screws used to mount the optical assembly bracket to the top cover are longer than the others.

3. Remove the Flat Gasket. Refer to [Figure 16](#).
4. Turn the top cover over and push the lens and gasket out of the pocket in the cover.



CAUTION

Cracked or broken glass is very sharp. Take necessary precautions to protect hands from being cut. Failure to follow this instruction can result in injury or equipment damage.

5. Make sure you do the following before you continue:

Option

If the lens is cracked, pitted, or damaged,

If just the gasket is damaged,

Description

discard the lens and gasket and replace with new lens and gasket.

replace the gasket on the lens.

6. Reassemble the light assembly in the opposite order as disassembled.
 - a) Torque the eight M6 torx head screws to 6 Nm.
 - b) Finger tighten the screws down against the Protection Plate. Torque the first screw and then torque the screw that is 180 degrees from the first screw. Repeat this process on each of the screws. Torque each screw to 6 Nm.
 - c) Apply silicon grease to the lens and Flat Gasket.

Figure 15: LED Board Assembly and Protection Plate

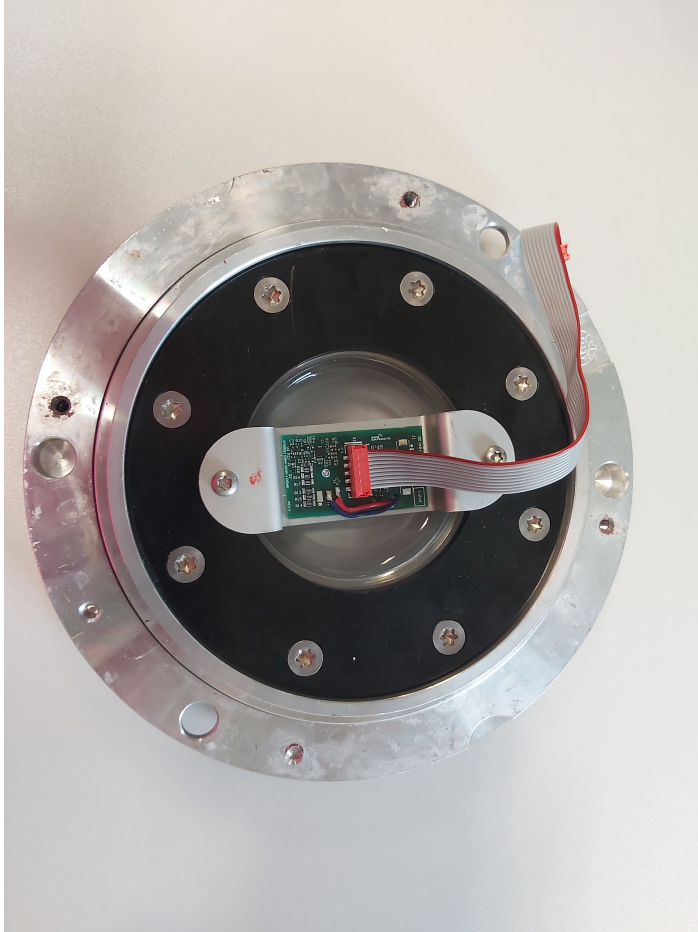
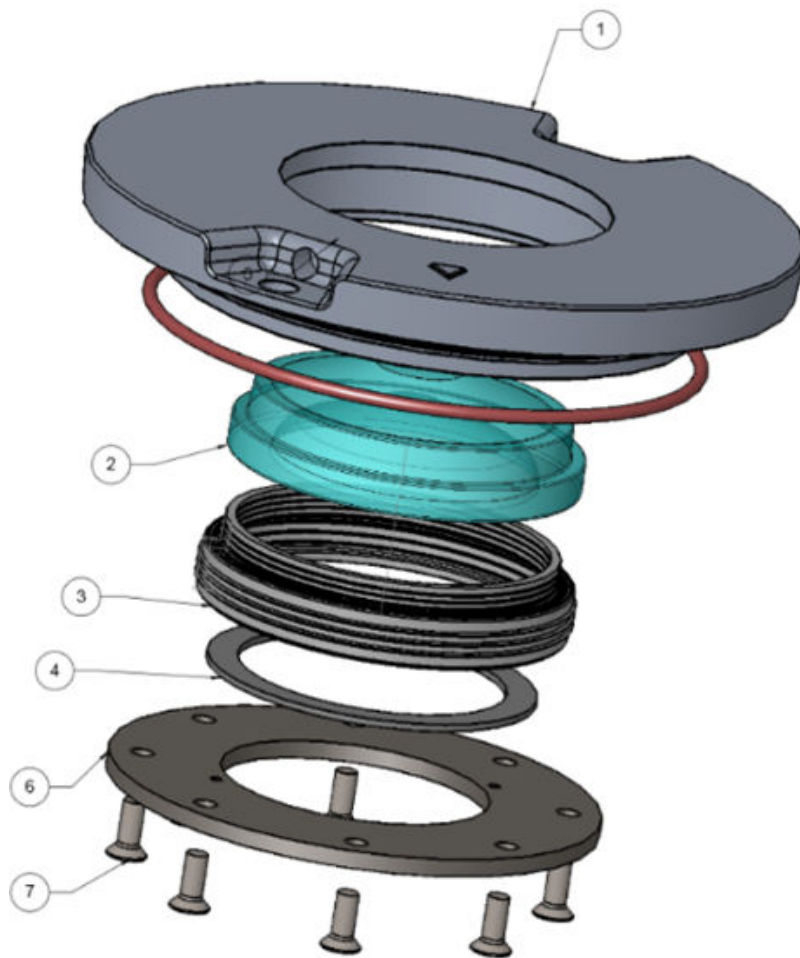
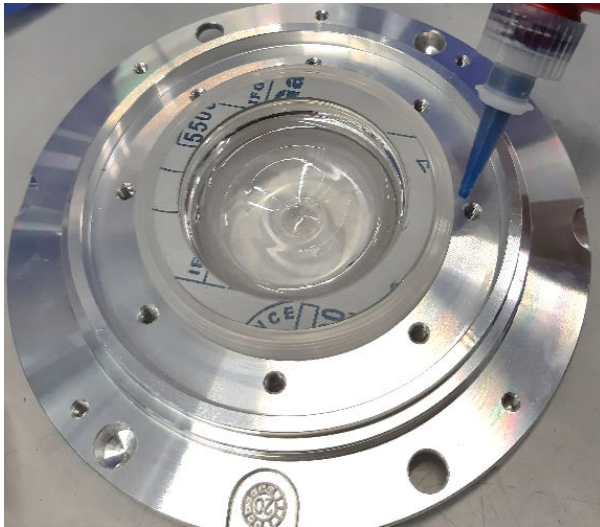

Figure 16: Lens and Flat Gasket



1 = Top cover

6 = Protection Plate

2 = Lens

7 = Screw M6 x 16

3 = Lens gasket

4 = Flat gasket

Figure 17: Lens Gasket



Figure 18: Grease Application

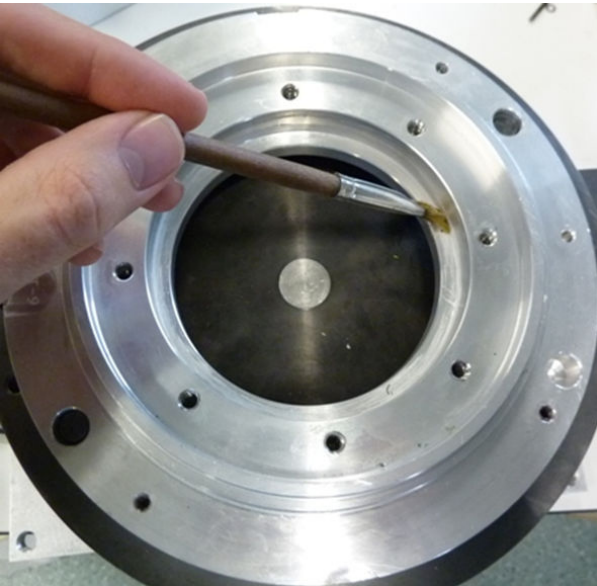

7. Clean the lens recess in the cover thoroughly with any effective solvent.
8. Place the lens with the Lens Gasket back.
Make sure that you use a new Lens Gasket.
9. Place the Flat Gasket back.
Make sure you use a new Flat Gasket.
10. Close the light fixture.
Refer to [Assembling a 8-inch Fixture](#) section.

6.4.9 Replacing the Top Cover Assembly



NOTICE

Top covers are delivered without the LED board assembly. LED board assemblies have to be ordered separately.

1. Open the light assembly: Refer to [Disassembling the Light Fixture](#) section.
2. Disconnect the top cover from the bottom cover.
3. Use a new top cover and go to [Assembling a 8-inch Fixture](#) section.

-
4. Disassemble the LED board assembly from the old top cover. Refer to [Replacing the LED Board Assembly](#) section.
 5. Assemble the new top cover with the LED board assembly. Refer to [Replacing the LED Board Assembly](#).

6.4.10 Replacing the LED Board Assembly

The LED board assembly includes the LED, the connection board and the bracket.



NOTICE

Replace the lens gasket to mount the LED board assembly when a new fixture is delivered. The lens gasket that is mounted upon receipt are only mounted as a transportation protection. Make sure you throw it away!



WARNING

Turn off the circuit before replacing LEDs. Failure to observe this warning may result in personal injury, death, or equipment damage.

Failure to follow this instruction can result in injury or equipment damage.



Note

Refer to the [Spare Parts](#) section.

To replace the LED assembly, perform the following procedure:

1. Open the light assembly.

Refer to [Disassembling the Light Fixture](#) section.

2. Refer to [Replacing LED Assembly](#) figure.

Unscrew the two M6 torx head screws that fasten the LED Optical Assembly bracket to the top cover. Remove the brackets from the prisms being in place when they are delivered to mount the LED board.

i Note
Refer to [Figure 20](#) figure.

Figure 19: LED board assembly (Optical assembly)

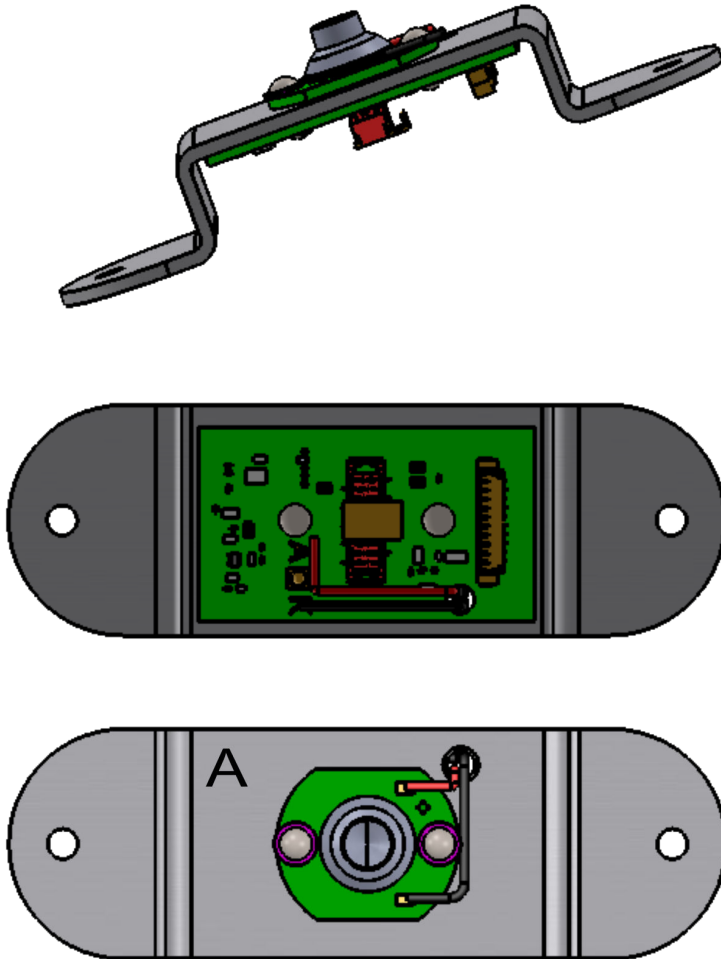

3. Disconnect the LED leads from the PCB and remove and discard the existing LED Optical Assembly.
Refer to the [Figure 8](#) figure.
4. Install the new LED Optical Assembly (purchased as a complete assembly) and torque screws to 2.5 Nm.
Re-connect the LED lead to the terminal on the PCB.

5. Refer to [Closing and Testing Light Assembly](#) section.

Figure 20: Optical Assembly Removal

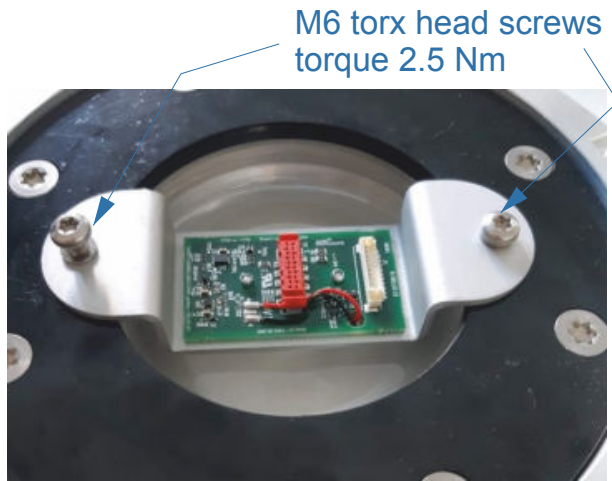

6. Put the new LED assembly in place. Fix it with the screws with the correct torque.

Figure 21: LED Board connection

Red Orientation Line



6.4.11 Replace the Bottom Cover Assembly

1. Disassemble the light fixture. Refer to [Disassembling the Light Fixture](#) section.

Figure 22: Bottom cover assembly and top cover assembly

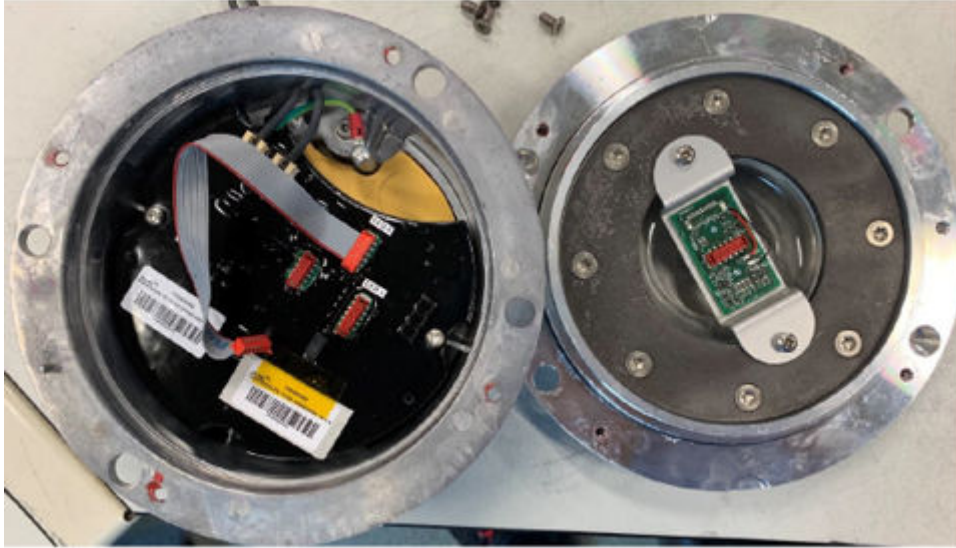

2. Replace the O-ring.
3. From inside the housing, disconnect the connector from the LED board. Refer to [Replacing the LED Board Assembly](#) section.
4. Replace the bottom cover.
5. Assemble the light fixture. Refer to [Assembling a 8-inch Fixture](#) section.

6.4.12 Resetting the Fail-open Converter

Parts

- Fuse resistor spare part kit: 6132.00.250 (20pcs)

Info

- Converter with 1 connector have 2 fuse resistors

Resetting / replacing the fuse resistors

1. Disconnect and disassemble the light fixture.
2. Locate the fuse resistors.



Note

Refer to [Figure 23](#) figure.

Figure 23: Converter with 1 connector

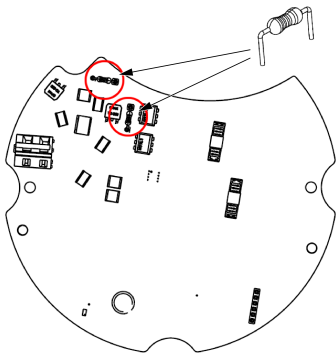

3. Remove the fuse resistors by pulling away from the converter: For converters with 1 connector, always replace both fuse resistors at the same time.
4. Dispose the old fuse resistor.
5. Place the legs of the new fuse resistors in the sockets.
6. Assemble the light fixture and perform a functional test.

6.4.13 Checking the Light Fixture for Water-tightness

To test for leaks, perform the following procedure for at least 3 minutes:

1. Refer to [Figure 24](#) figure.

Remove pressure relief screw.

2. Refer to [Figure 25](#) figure.

Screw pressure test fitting into the pressure relief port (the opening created when the pressure relief screw is removed).
Screw fitting hand-tight.

Figure 24: Pressure Relief Screw

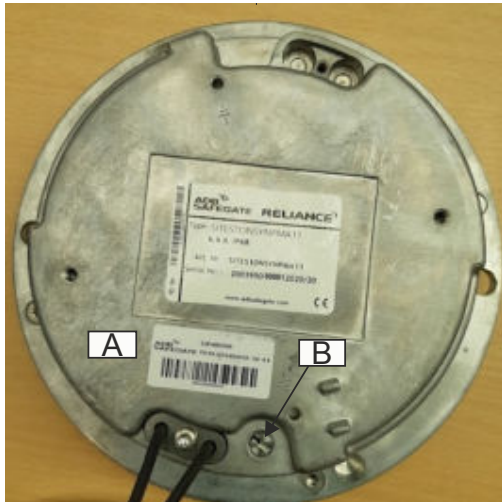

A = Inner pan cover

B = Pressure release screw

Figure 25: Pressure Test Fitting Assembly

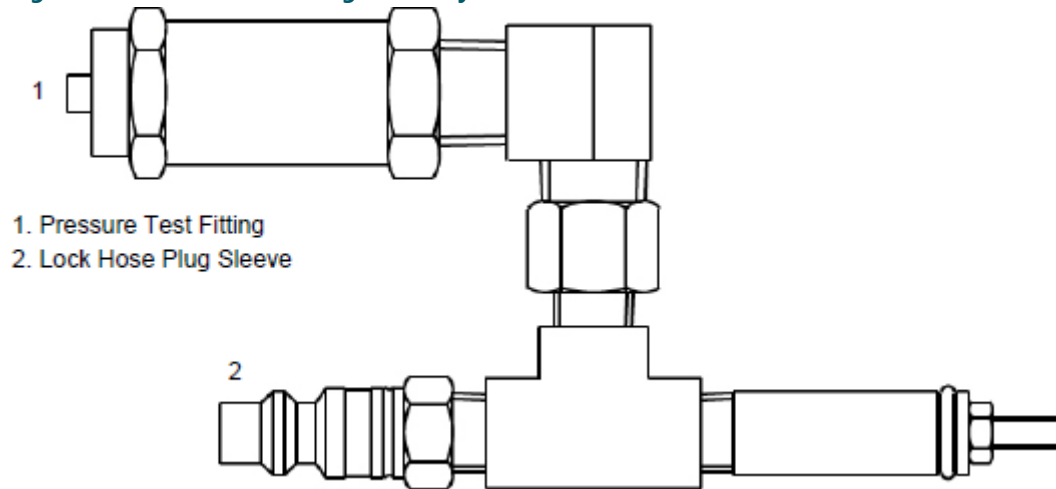

1. Pressure Test Fitting

2. Lock Hose Plug Sleeve

3. Attach the shop airline to the lock hose plug sleeve (2 in [Figure 25](#)).
4. Pressurize to 20 psi.
5. Submerge the pressure test fitting in a water tank.
Check for air bubbles. Air bubbles indicate a leak.
6. Locate the leak source, depressurize, replace the seal that is leaking, reassemble, and retest by following steps 4 and 5.
If leak is fixed, depressurize and reinstall the pressure release screw (1 in [Figure 25](#)).

Go to [Installation](#) to finish.

7.0 Troubleshooting



WARNING

Allow only qualified personnel to perform the following tasks. Observe and follow the safety instructions in this document and all other related documentation.

De-energize the circuit and lock out the circuit or regulator so that the circuit cannot be energized by remote means before attempting to service the fixture.

Failure to follow this instruction can result in injury or equipment damage.

This section contains troubleshooting information. This information covers only the most common problems that you may encounter. If you cannot solve the problem with the information given here, contact your local ADB Safegate representative for help.

Troubleshooting procedures for the inset lights are contained here.

Table 4: Troubleshooting Procedures

Problem	Possible Cause	Corrective Action
1. LED not energizing	LED defective PCB defective	Replace Optical LED assembly. Refer to Replacing LED Assembly . Replace the PCB See Testing a LED Assembly .
	Loose LED leads	Replace Optical assembly
	Moisture inside assembly causing current leakage	Open up light assembly. Clean, dry, and inspect light assembly. Replace the O-ring.
	No connection of primary circuit. Defective L-830 isolation transformer or secondary wiring	Check transformer output current with true RMS ammeter. Check power line between the light fixture and the transformer, including connectors.
	Light fixtures have gone into fail-open mode	Replace the fuse resistors.
2. Weak light output	Partial short circuit in primary loop	Check cable assembly.
	Defective L-830 isolation transformer	Replace transformer.
	Dirty lens	Clean lens. Refer to Cleaning the Lens .
3. Light beam distorted	Broken or damaged lens /cover	Replace lens or entire fixture. Refer to Replacing Lens and Flat Gasket .
4. Short LED life	Current too high	Check output current of isolating transformer at full brightness. Current should not exceed 6.7 A. Replace transformer if defective; if not, adjust CCR output current.
	Moisture in lighting fixture	<ol style="list-style-type: none"> 1. Open light assembly. Refer to <i>Opening optical assembly</i> in the <i>Repair</i> section. 2. Check for cause of leakage (dirty or damaged o- ring seal mating surfaces, defective lens seals, cracked or broken lens, loose screws or damaged wire insulation). 3. Clean, dry, inspect, or replace damaged components.

8.0 Spare Parts

Spare parts are available for RELIANCE and RELIANCE IQ inset light fixtures. For more information, see www.adbsafegate.com and the spare part lists, or contact ADB SAFEGATE for assistance.

8.1 Ordering Code Taxiway Edge omnidirectional Light

The illustration below clarifies the structure of the ordering code for the RELIANCE Taxiway Edge Omni with one dome.

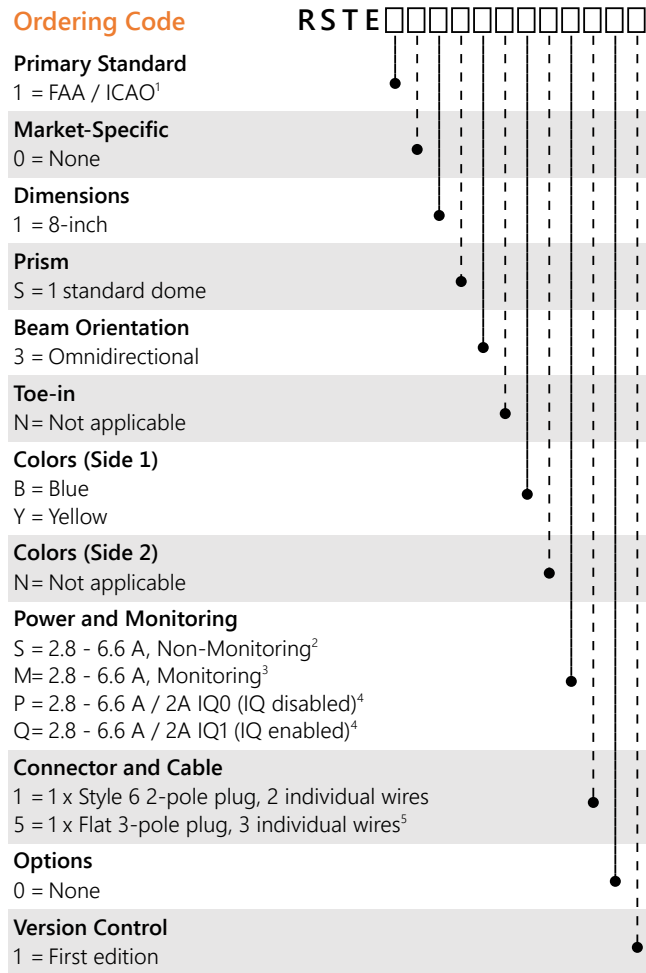

- Notes**
- 1 Option 1 covers other compliance: MOS.
 - 2 Power only
 - 3 With fail-open
 - 4 The IQ-functionality allows control and monitoring of the RELIANCE IQ. IQ1 fittings are pre-configured for the specific position at delivery. This function is disabled in IQ0 fittings but could be enabled in a later state. IQ light fixtures are only available as one connector option.
 - 5 French 3-pin plug

8.2 Components

	Components	Versions	Article number	Packing ¹
1	Omni 1D Bottom cover assembly	Full Inner Pan assembly for IQ lights	SP.013056	Per 1
		Full Inner Pan assembly for FO (MON) lights	SP.013057	Per 1
		Full Inner Pan assembly for NON-MON lights	SP.013058	Per 1
2	Omni 1D Top Cover	Full top cover assembly (including top cover, lens, lens protection, lens support, gaskets, screws, gasket (O-ring or labyrinth))	SP.013059	Per 1
3	Omni 1D Light	Full dome assembly (including lens, lens protection, lens support, gaskets, screws, gasket (O-ring or labyrinth))	SP.013060	Per 1
4	OMNI 1D LED	LED board assembly - blue - TWY edge (including screws and LED cable)	SP.013061	Per 1
		LED board assembly - yellow - Intermediate holding position (including screws and LED cable)	SP.013062	Per 1
5	OMNI 1D LED Cables	Set of LED cables	SP.SGE48000747	Per 10
6	OMNI 1D Bottom Cover Gaskets	Set of bottom cover gaskets	SP.7080.90.335	Per 10
7	OMNI 1D Lens Gaskets	Set of lens gaskets	SP.4071.76.041	Per 20
8	OMNI 1D Flat Gasket	Set of flat gaskets	SP.4071.76.060	Per 20

Notes

¹ Example: If you order 1× article number SP.SGE48000747, you will receive 10 cables.

8.3 Screws Overview

Screw type	Description	Quantity on a fixture	Torque (Nm)
M4×6 DIN7985-T-A2	Torx head screw for LED bracket	2	2.5 Nm
M6x16 DIN 965 A -T-A4	Torx metric caps screw for Protection plate	8	6 Nm
M4x12 DIN 7985-T-A4 + Loctite 2045	Connection screws (2) between converter and bottom cover; Screw (1) for connection of earthing cable with bottom cover	3	1.5 Nm
M4X12 DIN 7985-T-A4 + Loctite 2045	Fixation for cable disc	1	3.5 Nm
	Pressure release screw	1	3.5 Nm
M5x10 + Loctite 2045	Connection screw between bottom cover and top cover	4	3.5 Nm

9.0 INTEROPERABILITY

Base installation – O-ring selection and retaining bolts for 12-inch



CAUTION

Use of incorrect combination of gaskets, bolts and nuts can create severe damages to the product installation and create multiple safety risks.

To obtain a safe and watertight installation the O-ring and retaining bolt stated in the document must be used.

You need to know what base the light fixture will be installed in, in order to choose the correct gasket, bolts and nuts.

Failure to follow these cautions can result in equipment damage or aircraft FOD.

Table 5: Interoperability matrix

Base type	Required O-ring	Bolt installation		Stud installation	
		Required dimension	Recommended torque	Required nut	Recommended torque
ADB 8" Eurobase	White labyrinth gasket 4072.24.781 / 1pc 4072.76.560 / 10pc 4072.76.570 / 100pc	Metric screw kit 25mm 1411.20.522	21 Nm + Loctite 2701	Self-locking nut kit H100 1411.20.430	21 Nm + Loctite 2701
Safegate 8" - 135 mm; RELIANCE BASE 8" - 135 mm	White labyrinth gasket 4072.24.781 / 1pc 4072.76.560 / 10pc 4072.76.570 / 100pc	Metric screw kit 25mm 1411.20.522	40 Nm (No Loctite)	Self-lock nut kit H80 1411.20.435	35 Nm (No Loctite)
ERNI 8" EE08 - 150mm; ERNI 8" ED08 - 133 mm	RED labyrinth gasket 4071.73.100 / 1pc 4072.76.580 / 10pc 4072.76.590 / 100pc	Metric screw kit 25mm 1411.20.522	40 Nm (No Loctite)	Self-lock nut kit H80 1411.20.435	35 Nm (No Loctite)
Thorn 8" - 100 mm	Dep. On installation plugs Grey O-ring SGE48001264 SGE.SP24522 / 10pc SGE.SP24525 / 100pc	Dep. On installation plugs Metric screw kit 25 mm 1411.20.522	Dep. On installation plugs 40 Nm (No Loctite)	Dep. On installation plugs 4 Self-lock nut kit H80 1411.20.435	Dep. On installation plugs 35 Nm (No Loctite)
Thorn 8" - 133 mm	Grey O-ring SGE48001264 SGE.SP24522 / 10pc SGE.SP24525 / 100pc	Metric screw kit 25mm 1411.20.522	40 Nm (No Loctite)	Self-lock nut kit H80 1411.20.435 code	35 Nm (No Loctite)
Thorn 8" - MK2 133 mm	White labyrinth gasket 4072.24.781 / 1pc 4072.76.560 / 10pc 4072.76.570 / 100pc	Metric screw kit 25mm 1411.20.522	40 Nm (No Loctite)	Self-lock nut kit H80 1411.20.435 code	35 Nm (No loctite)

Table 5: Interoperability matrix (Continued)

Base type	Required O-ring	Bolt installation		Stud installation	
		Required dimension	Recommended torque	Required nut	Recommended torque
IDM 6494 (120mm)	White labyrinth gasket 4072.24.781 / 1pc 4072.76.560 / 10pc 4072.76.570 / 100pc	Metric screw kit 25mm 1411.20.522	40 Nm (No Loctite)	Self-locking nut kit H100 1411.20.430	35 Nm (No Loctite)
Adapter ring ADB 8"-12"	White labyrinth gasket 4072.24.781 / 1pc 4072.76.560 / 10pc 4072.76.570 / 100pc	Metric screw kit 25mm 1411.20.522	21 Nm + Loctite 2701	Self-locking nut kit H100 1411.20.430	21 Nm + Loctite 2701
Adapter ring SG/Thorn/ID 8"-12"	White labyrinth gasket 4072.24.781 / 1pc 4072.76.560 / 10pc 4072.76.570 / 100pc	Metric screw kit 25mm 1411.20.522	40 Nm (No Loctite)	Self-locking nut kit H100 1411.20.430	35 Nm (No Loctite)

10.0 POWER TABLE

Fixture type	Fixture load	Isolation transformer			CCR load
		Rating	Efficiency	Energy Use	
RS -TE (omnidirectional, inset blue)	20 VA	25 W	0.7	8 VA	28 VA
RS-TE (omnidirectional, inset yellow)	15 VA	25 W	0.7	6 VA	21 VA



NOTICE

- No losses in the secondary cables are considered in the above table.
- No losses in the primary cables are considered in the above table.
- No spare CCR load has been considered in the above table.
- The Isolation transformer efficiency considered in the above table is estimated. These efficiency values depend on the isolating transformer supplier.
- No loads due to extra equipment on the circuit (e.g. ILCMS equipment) are considered in the above table.
- For RELIANCE IQ version:
 - The minimum Isolation Transformer rating is 65W.
 - To allow for communication bandwidth, an overhead of 12VA should be considered when determining the Isolation Transformer rating.
- For RELIANCE Fail-open version:
 - The maximum Isolation Transformer rating is 200W.
- If part of a RELIANCE 2A system:
 - The data provided in the table above is not applicable if part of a 2A reliance system. In this case, please contact your local ADB Safegate representative.

Appendix A: CABLE LOSS

The cable resistance R (ohms) for 1 conductor is calculated with following formula:

- $R \text{ (ohms)} = \text{resistivity of material (ohm m)} \times \text{length (m)} / \text{cross sectional area (m}^2\text{)}$
- For copper conductors the resistivity is $1.72 \cdot 10^{-8} \text{ (m}^2\text{)}$

Example; for 1 km 2.5 mm^2 copper conductor, the resistance R is calculated as follows:

$$1.72 \cdot 10^{-8} \times 1000 / 2.5 \cdot 10^{-6} \text{ m}^2 = 6.88 \text{ ohms}$$

The loss (Watt) is then $R \times I^2$ or $6.88 \text{ ohms} \times 6.6^2 \text{ A}^2 = 299.69 \text{ W/km}$ or 0.299 W/m .

The loss (Watt) for a secondary cable with 2 conductors is thus $2 \times 0.299 = 0.599$ or 0.6 W/m .

As such we can calculate:

- Secondary cable for a 2.5 mm^2 Cu-wire (2 conductors): 0.6 W/m
- Secondary cable for a 4 mm^2 Cu-wire (2 conductors): 0.4 W/m
- Primary cable for a 6 mm^2 Cu-wire (1 conductor): 0.12 W/m

The cable between the isolation transformer and the lamp adds losses that cannot be ignored when dimensioning the circuits and selecting rating for secondary transformers and regulators.



WARNING

Cable lengths should not exceed 100 meters.

For a secondary cable of e.g., 20 m of 2.5 mm^2 CU-wire, $20 \text{ m} \times 0.6 \text{ W/m} = 12 \text{ W}$ equals the additional loss to be taken into account.

For a primary cable of e.g., 100 m of 6 mm^2 CU-wire, $100 \text{ m} \times 0.12 \text{ W/m} = 12 \text{ W}$ equals the additional loss to be taken into account.

Appendix B: SUPPORT

Our experienced engineers are available for support and service at all times, 24 hour/7 days a week. They are part of a dynamic organization making sure the entire ADB SAFEGATE is committed to minimal disturbance for airport operations.

ADB SAFEGATE Support

Live Technical Support - Americas

If at any time you have a question or concern about your product, just contact ADB SAFEGATE's technical service department. Trained in all areas of system issues, troubleshooting, quality control and technical assistance, our highly experienced Technical support specialists are available 24 hours a day, seven days a week to provide assistance over the phone.

ADB SAFEGATE **Americas Technical Service & Support (US & Canada): +1-800-545-4157**

ADB SAFEGATE Americas Technical Service & Support (International): +1-614-861-1304

During regular business hours, you can also Chat with a Service Technician. We look forward to working with you!

Before You Call

When you have an airfield lighting or system control system problem it is our goal to support airfield maintenance staff as quickly as possible. To support this effort we ask that you have the following information ready before calling.

- The *airport code*
- If not with an airport, then company name (prefer customer id number)
- Contact phone number and email address
- Product with part number preferable or product number
- Have you reviewed the product's manual and troubleshooting guide
- Do you have a *True RMS* meter available (and any other necessary tools)
- Be located with the product ready to troubleshoot

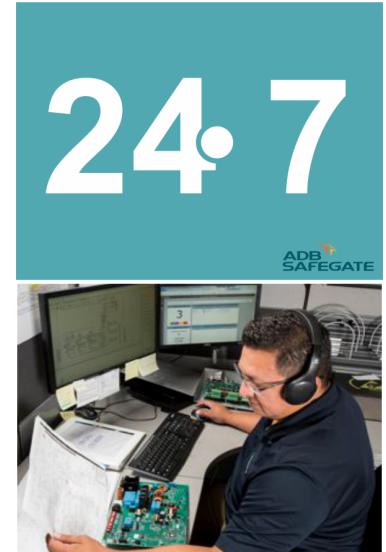

Note

For more information, see www.adbsafegate.com, or contact ADB SAFEGATE Support via email at support@adbsafegate.com or

Brussels: +32 2 722 17 11

Rest of Europe: +46 (0) 40 699 17 40

Americas: +1 614 861 1304. Press 3 for technical service or press 4 for sales support.

China: +86 (10) 8476 0106

B.1 ADB SAFEGATE Website

The ADB SAFEGATE website, www.adbsafegate.com, offers information regarding our airport solutions, products, company, news, links, downloads, references, contacts and more.

B.2 Recycling

B.2.1 Local Authority Recycling

The disposal of ADB SAFEGATE products is to be made at an applicable collection point for the recycling of electrical and electronic equipment. The correct disposal of equipment prevents any potential negative consequences for the environment and human health, which could otherwise be caused by inappropriate waste handling. The recycling of materials helps to conserve natural resources. For more detailed information about recycling of products, contact your local authority city office.

B.2.2 ADB SAFEGATE Recycling

ADB SAFEGATE is fully committed to environmentally-conscious manufacturing with strict monitoring of our own processes as well as supplier components and sub-contractor operations. ADB SAFEGATE offers a recycling program for our products to all customers worldwide, whether or not the products were sold within the EU.

ADB SAFEGATE products and/or specific electrical and electronic component parts which are fully removed/separated from any customer equipment and returned will be accepted for our recycling program.

All items returned must be clearly labeled as follows:

- For *ROHS/WEEE* Recycling
- Sender contact information (Name, Business Address, Phone number).
- Main Unit Serial Number.

ADB SAFEGATE will continue to monitor and update according for any future requirements for *EU directives* as and when *EU member states* implement new *regulations* and or *amendments*. It is our aim to maintain our *compliance plan* and assist our customers.

Company Addresses

ADB SAFEGATE	ADB SAFEGATE, Belgium: Leuvensesteenweg 585, B-1930 Zaventem Belgium
Contact: Tel.: +32 2 722 17 11, Fax: +32 2 722 17 64	Email: marketing@adbsafegate.com Internet: www.adbsafegate.com
Americas LLC	ADB SAFEGATE, Americas: 977 Gahanna Parkway, Columbus, OH 43230 USA
Contact: Tel.: +1 (614) 861 1304, Fax: +1 (614) 864 2069	Email: sales.us@adbsafegate.com Internet: www.adbsafegate.com
ADB SAFEGATE Sweden AB	ADB SAFEGATE, Sweden: Djurhagegatan 19 SE-213 76 Malmö Sweden
Contact: Tel.: +46 (0)40 699 17 00, Fax: +46 (0)40 699 17 30	Email: marketing@adbsafegate.com Internet: www.adbsafegate.com
ADB SAFEGATE Airfield Technologies Ltd. China	ADB SAFEGATE, China: Unit 603, D Block, CAMIC International Convention Center, No 3, Hua Jia Di East road, ChaoYang district, Beijing 100102 P.R. China
Contact: Tel.: +86 (10) 8476 0106, Fax: +86 (10) 8476 0090	Email: china@safegate.com Internet: www.adbsafegate.com
ADB SAFEGATE Germany GmbH	ADB SAFEGATE Germany GmbH, Mannheim: Konrad-Zuse-Ring 6, D-68163 Mannheim Germany
Contact: Tel.: +49 (621) 87 55 76-0, Fax: +49 (621) 87 55 76-55	Email: marketing@adbsafegate.com Internet: www.adbsafegate.com



Powering Your Airport Performance from Approach to Departure

adbsafegate.com

Copyright © ADB SAFEGATE, all rights reserved

