



---

# Hali-Brite®

---

## Installation and Maintenance Manual

### SPS Solar Power Supply



Hali-Brite® Inc.  
1119 Madison St  
Brainerd, MN 56401  
Tel: 800.553.6269  
Fax: 218.454.0972  
[www.halibrite.com](http://www.halibrite.com)

200W Panel 59.2" x 26.5"

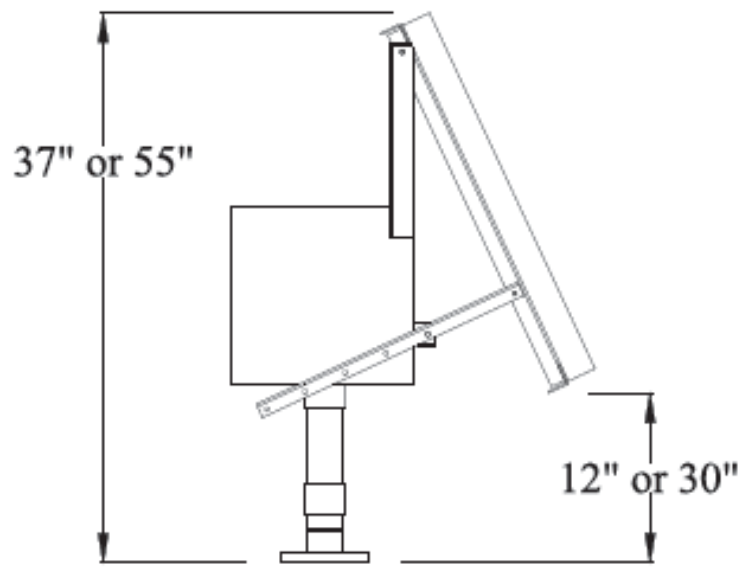
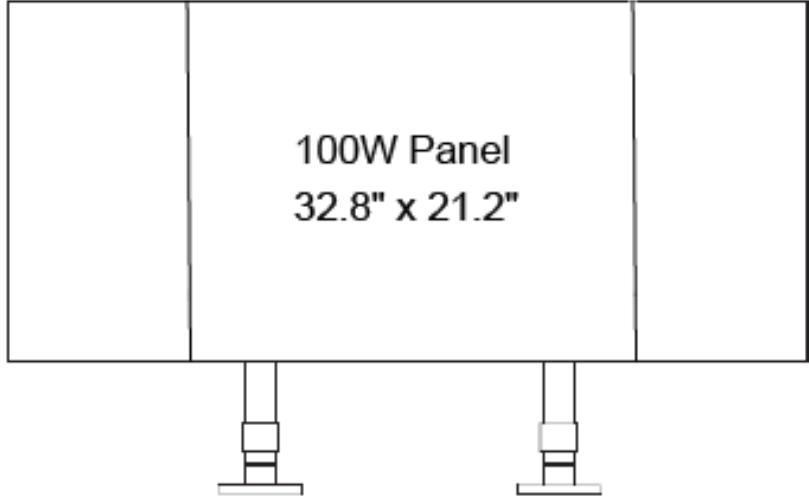

**Anchor Assembly Top View**

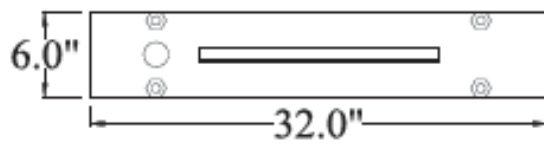

# Table of Contents

1	Introduction.....	4
1.1	About this Manual.....	4
1.2	Model Configurations.....	4
1.3	Warranty.....	4
1.4	Disclaimers.....	5
2	Safety Precautions.....	6
2.1	Safety Statements.....	6
2.2	General Practices.....	6
2.3	Electrical Practices.....	7
2.4	Qualified Personnel.....	8
2.5	Proper Usage.....	8
3	Specifications.....	9
3.1	Electrical Specifications.....	9
3.2	Physical Specifications.....	9
3.3	Environmental Specifications.....	9
4	Installation.....	10
4.1	Unpacking.....	10
4.2	Tools and Supplies Needed.....	10
4.3	Installation.....	11
5	Maintenance.....	19
5.1	Maintenance Schedule.....	19
6	Repair.....	20
6.1	Battery Replacement.....	20
6.2	Fuse Replacement.....	20
6.3	Solar Panel Replacement.....	21
6.4	Charge Controller Replacement.....	22
6.5	Frangible Coupling Replacement.....	23
6.6	Solar Panel Angle Adjustment.....	25
6.7	Photocell Replacement.....	<b>Error! Bookmark not defined.</b>
7	Replacement Parts.....	26

# 1 Introduction

## 1.1 About this Manual

The information in this manual is provided to assist installation and maintenance personnel in the proper installation, upkeep, and maintenance of the SPS Solar Power Supply.

## 1.2 Model Configurations

SPS-100-2-12: 100 watt panel, 2 batteries, 12" legs

SPS-100-2-30: 100 watt panel, 2 batteries, 30" legs

SPS-200-2-12: 200 watt panel, 2 batteries, 12" legs

SPS-200-2-30: 200 watt panel, 2 batteries, 30" legs

## 1.3 Warranty

**Solar Panel:** The solar panel warranty is offered by the manufacturer, BP Solar. Please refer to the warranty materials included with this manual, and contact the manufacturer directly for warranty claims.

**Batteries:** The battery warranty is offered by the manufacturer, Concorde Battery Corporation. Please refer to the warranty materials included with this manual, and contact the manufacturer directly for warranty claims.

The warranty for the other components of the SPS is offered by Hali-Brite® as follows:

Hali-Brite® products are guaranteed against mechanical, electrical, and physical defects (excluding lamps) for a period of one year from the date of installation or a maximum of two years from the date of shipment and are guaranteed to be merchantable and fit for the ordinary purposes for which such products are made. Hali-Brite® will correct by repair or replacement, at its option, equipment or parts which fail because of mechanical, electrical or physical defects, provided that the goods have been properly handled and stored prior to installation, properly installed and properly operated after installation, and provided further that Buyer gives Hali-Brite® written notice of such defects after delivery of the goods to Buyer. Hali-Brite® reserves the right to examine goods upon which a claim is made. Said goods must be presented in the same condition as when the defect therein was discovered. Hali-Brite® further reserves the right to require the return of such goods to establish any claim. Hali-Brite's obligation under this guarantee is limited to making repair or replacement within a reasonable time after receipt of such written notice and does not include any other costs such as the cost of removal of defective part, installation of repaired product, labor or consequential damages of any kind, the exclusive remedy being to require such new parts to be furnished. Hali-Brite's liability under no circumstances will exceed

the contract price of goods claimed to be defective. Any returns under this guarantee are to be on a transportation charges prepaid basis. For products not manufactured by, but sold by Hali-Brite®, warranty is limited to that extended by the original manufacturer. This is Hali-Brite's sole guarantee and warranty with respect to the goods; there are no express warranties or warranties of fitness for any particular purpose or any implied warranties of fitness for any particular purpose or any implied warranties other than those made expressly herein. All such warranties being expressly disclaimed. Details and values given in this manual are average values and have been compiled with care. They are not binding, however, and Hali-Brite® disclaims any liability for damages or detriments suffered as a result of reliance on the information given herein or the use of products, processes or equipment to which this manual refers. No warranty is made that the use of the information or of the products, processes or equipment to which this manual refers will not infringe any third party's patents or rights. The information given does not release the buyers from making their own experiments and tests.

#### **1.4 Disclaimers**

This manual is published for informational purposes only and the information provided should not be considered as all-inclusive or covering all contingencies. If further information is required, Hali-Brite® Inc. should be contacted. Sale of the product shown in this manual is subject to Hali-Brite's terms and conditions including, but not limited to, the Hali-Brite® Warranty. Such terms and conditions are available upon request. Hali-Brite's warranty will not apply to any products which have been "so repaired or altered outside the manufacturer's plants as, in the manufacturer's judgment, to affect its reliability and performance."

No warranties, express or implied, including warranties of fitness for a particular purpose or merchantability, or warranties arising from course or dealing or usage of trade, are made regarding the information, recommendations, and descriptions contained herein. The manufacturer is not responsible and will not be held liable in contract or in tort (including negligence) for any special, indirect or consequential damages, including injury or damage caused to vehicles, contents or persons, by reason of the installation of any Hali-Brite® product or its mechanical or electrical failure.

# 2 Safety Precautions

To help you install and maintain this equipment safely and efficiently make sure you read and understand all safety information in this manual prior to performing any procedure. Failure to do so may result in personal injury, property damage, or possible death.

## 2.1 Safety Statements

The following safety statements are used throughout this manual. They will alert you to possible safety hazards and conditions that could result in personal injury, death, or property and equipment damage.

***CAUTION: Indicates hazards or unsafe practices that could result in minor personal injury, product, or property damage.***

***WARNING: Indicates hazards or unsafe practices that could result in severe personal injury or death.***

***DANGER: Indicates immediate hazards that will result in severe personal injury or death.***

## 2.2 General Practices

Read and become familiar with the general safety instructions provided in this section of the manual before installing, operating, maintaining, or repairing this equipment.

- Do not attempt to assemble or install this equipment if it has been damaged from shipping.
- Do not attempt to install or maintain this equipment if you or the equipment is standing in water.
- Only qualified personnel should perform maintenance on this equipment.
- Always use proper tools (as mentioned in this manual) to perform installation and maintenance.
- Use proper hand and eye protection as needed when installing or maintaining this equipment.
- Make sure you have adequate first aid supplies available when installing this equipment.

- Do not modify this equipment as this could create a safety hazard and void your Hali-Brite® warranty.
- Use only Hali-Brite® replacement parts.
- Read and carefully follow the instructions given throughout this manual for performing specific tasks and working with specific equipment.
- Follow all applicable safety procedures required by your company, industry standards, and government or other regulatory agencies.
- Make sure all equipment is rated and approved for the environment in which you are using it.
- Follow all instructions for installing components and accessories.
- Protect components from damage, wear, and harsh environment conditions.
- Allow ample room for maintenance, wiring accessibility, and cover removal.

### **2.3 Electrical Practices**

- Do not attempt to make electrical connections with the power on.
- Disconnect and lock out electrical power before touching any electrical connections.
- Install all electrical connections to local code.
- Use only electrical wire of sufficient gauge and insulation to handle the rated current demand. All wiring must meet local codes.
- Route electrical wiring along a protected path. Make sure moving equipment will not damage it.
- Protect equipment with safety devices as specified by applicable safety regulations.
- If safety devices must be removed for installation, install them immediately after the work is completed and check them for proper functioning.
- Always use rated electrical tools when performing electrical work.
- Always make sure electrical connections are tight.
- Make sure electrical covers are in place after installation.

- Do not touch hot lamps with bare hands.

## **2.4 Qualified Personnel**

Qualified personnel are those that are trained and experienced with installing or maintaining Hali-Brite® equipment. Only qualified personnel should install or maintain Hali-Brite® equipment and auxiliary features.

No one should:

- Attempt to install or perform maintenance on this or any Hali-Brite® equipment if they are physically impaired or under the influence of alcohol or non-prescription drugs.
- Maintain or install this equipment without correct training, supervision or experience in mechanical or electrical equipment.
- Attempt to maintain or install this equipment without the correct tools as specified in this manual.

## **2.5 Proper Usage**

Always use this equipment as specified in this manual. Improper usage may result in serious personal injury, property damage, or possible death.

- Do not make any modifications that have not been recommended by Hali-Brite®.
- Do not use any replacement parts that are not purchased from Hali-Brite®.
- Hali-Brite® cannot be responsible for injuries or damages resulting from nonstandard, unintended applications of its equipment. This equipment is designed and intended only for the purpose described in this manual. Uses not described in this manual are considered unintended uses and may result in serious personal injury, death, or property damage.



# 3 Specifications

## 3.1 Electrical Specifications

Batteries.....	(2) or (3) 12 VDC, 100 A-hr
Type.....	AGM
Life.....	4000 charge/discharge cycles, typical
Charge Controller.....	Temperature compensated, maximum power point tracking
Status Indicators.....	Battery state of charge, charging, system status
Light Control.....	Dusk to Dawn
Photovoltaic Panel.....	100 or 200 watt
Load.....	8-13 watts
Autonomy.....	10 days typical

## 3.2 Physical Specifications

Dimensions	
Height.....	37-55 inches (94-140 cm)
Width.....	59 or 33 inches (150 or 84 cm)
Mounting .....	(2) frangible couplings and flanges to a 6 x 32 inch anchor assembly with (4) 5/8 inch mounting bolts.
Product Weight.....	196-278 lb. (87-126 kg)
Shipping Weight .....	276-398 lb. (125-180 kg)

## 3.3 Environmental Specifications

Operating Temperature .....	-40°C (-40°F) to +55°C (+131°F)
Humidity .....	0% to 100%
Altitude .....	Sea level to 10,000 feet (3000 m)
Wind.....	120 mph minimum

# 4 Installation

**WARNING:** Allow only qualified personnel to perform the following tasks. Observe and follow the safety instructions in this document and all other related documentation.

## 4.1 Unpacking

Handle the equipment very carefully to prevent component damage. Note any exterior damage to the carton/crate that might lead to detection of equipment damage. If you note any damage to any equipment, file a claim with the carrier immediately. The carrier may need to inspect the equipment. A typical shipping crate (including an L-806 wind cone) is shown below:

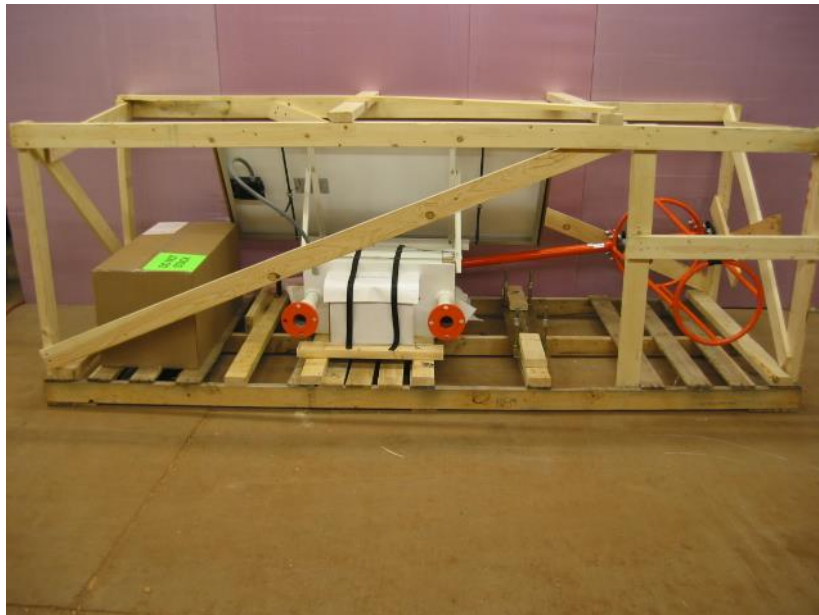

Figure 1

**Note:** To prevent damage to the equipment, transport the pallet to the installation site before removing the SPS components from the pallet. The anchor assembly may be removed earlier for preparing the mounting base.

## 4.2 Tools and Supplies Needed

Equipment Required But Not Supplied

Wrenches  
Set of Screwdrivers  
Set of Pliers

- Level
- 2 Pipe Wrenches
- Liquid Glass Cleaner
- 1 inch conduit, as needed to connect the wind cone to the SPS
- Concrete and materials to construct the mounting base

### 4.3 Installation

The following procedure describes the site preparation, construction of the mounting base, and final wiring and checkout of the SPS.

#### 4.3.1 Site Planning

The wind cone and SPS locations and mounting bases must be properly planned prior to construction. Full sun exposure is critical to proper operation of the SPS. Therefore, the SPS must be located on the south side of the wind cone in the northern hemisphere, and on the north side of the wind cone in the southern hemisphere. **The front of the solar panel must face the equator.**

**The SPS shall be located 8 to 15 feet from an L806 or L807 Size 1 wind cone, and 12 to 15 feet from an L807 Size 2 wind cone.**

Electrical cable to connect the wind cone to the SPS is supplied with the wind cone (additional cable may be required). This cable is not suitable for direct burial. The following instructions assume this cable is contained in 1 inch conduit between the wind cone and the SPS, with 1 inch conduit elbows at each end.

Refer to the Installation Manual supplied with the wind cone for wind cone installation procedures.

#### 4.3.2 Construct the Mounting Base

Figure 2 illustrates the completed SPS installation, mounted on a concrete slab.

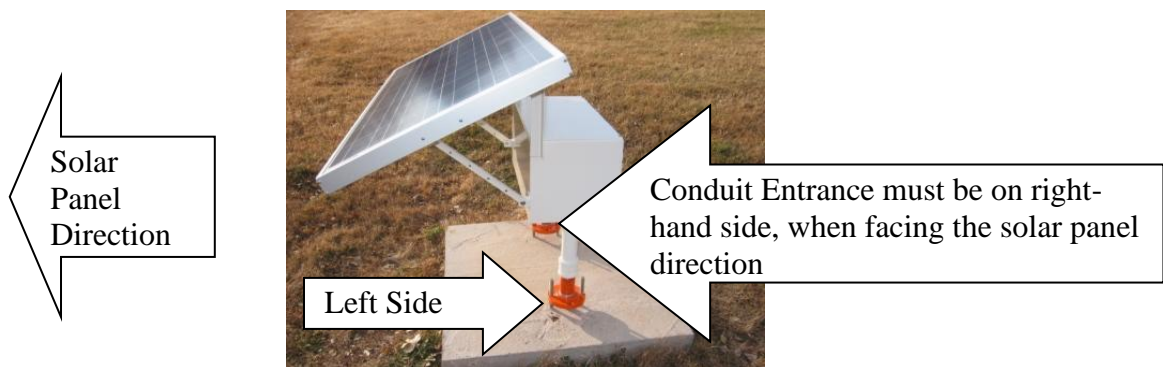

Figure 2. Completed Installation

Note the location of the conduit entrance in Figures 2 and 3. **If the conduit is installed on the wrong side, the solar panel will be facing the wrong direction.**

Refer to Figure 3 to guide construction of the SPS mounting base. Perform the following steps:

1. Locate the anchor assembly included with the SPS.
2. Orient the anchor assembly as shown in Figure 3.
3. Trench and bury the 1 inch conduit from the wind cone location to the SPS location.
4. Construct concrete forms as shown in Figure 3. The concrete base should be a minimum of 40 inches square, and at least 3 ½ inches thick.
5. Orient the SPS anchor assembly in the center of the base, with the conduit entrance as shown. Place blocks under anchor assembly as needed to ensure the anchor bolts will protrude about 4 inches above the top of the finished concrete surface. Make sure the 2 mounting nuts and washer on each anchor bolt will be above the top surface of the concrete.
6. Ensure the conduit will protrude 2-3 inches above the top of the finished concrete surface.
7. Pour the concrete, allow it to cure, and remove the forms.

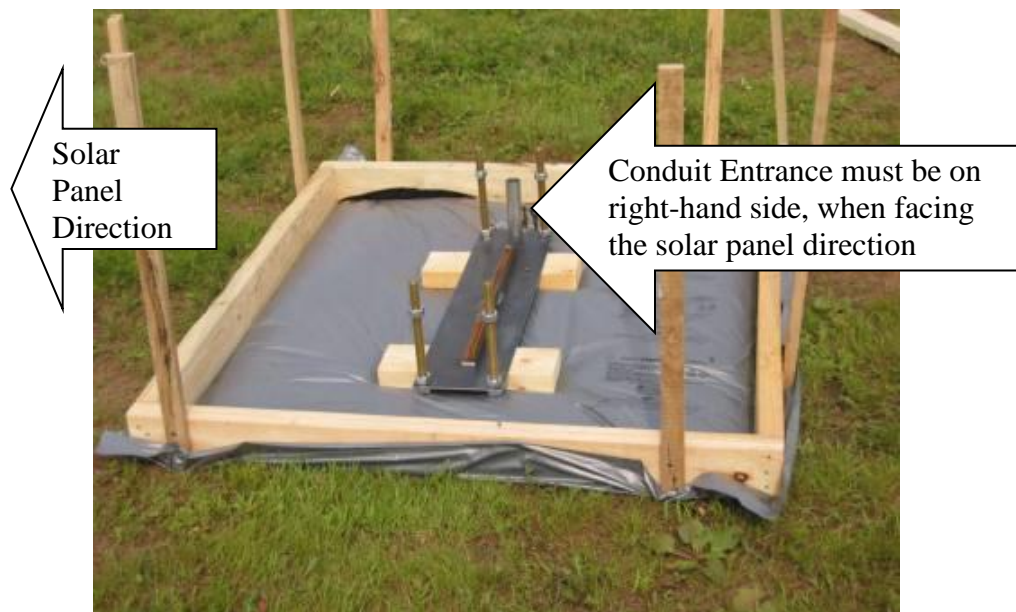

Figure 3. Mounting Base Layout

#### 4.3.3 Install the SPS to the Mounting Base

Proceed as follows to install the SPS to the mounting base:

1. Pull the electrical cable from the wind cone, through the conduit, and through the conduit elbow in the SPS mounting base.
2. Bring the SPS, on its shipping pallet, to the installation site.
3. Remove the top boards from the pallet, and position the pallet next to the mounting base, as shown in Figure 4.
4. On some SPS models the 2 mounting legs are factory installed, and on some models these legs are installed in the field. If this unit does not have mounting legs installed, locate and install them. Tighten them securely with pipe wrenches.



Figure 4. Cable Installation

5. **Note: Do not remove the protective cover from the solar panel until instructed to do so.**
6. Remove the cover from the SPS battery enclosure.
7. Feed the electrical cable through the mounting leg of the SPS, and into the battery enclosure.
8. Remove the top nut and lock washer from each of the 4 anchor bolts. One nut should remain on each of the 4 bolts.
9. **Caution: The following step should be performed by 2 people:** Lift the SPS from the pallet, and guide the mounting legs on to the 4 mounting bolts. Install a lock washer and nut on to each of the 4 mounting bolts.
10. The bottom nuts on the mounting bolts are used to level the SPS. Place a level on the top surface of the battery compartment, and adjust the 4 bottom nuts until the battery compartment is level in all directions.
11. Tighten the top nut on each of the 4 mounting bolts to secure the SPS to the mounting base.

#### 4.3.4 Connect the Power Cable from the Wind Cone to the SPS

Proceed as follows to connect the wind cone power cable to the SPS:

1. Locate the power cable from the wind cone, inside the battery enclosure, as shown in Figure 5.
2. Locate the White and black wires with wire nuts attached to each end.

3. Remove the wire nut from the black wire, and use this wire nut to connect this black wire to the black wire from the wind cone power cable.
4. Remove the wire nut from the white wire, and use this wire nut to connect this white wire to the white wire from the wind cone power cable.

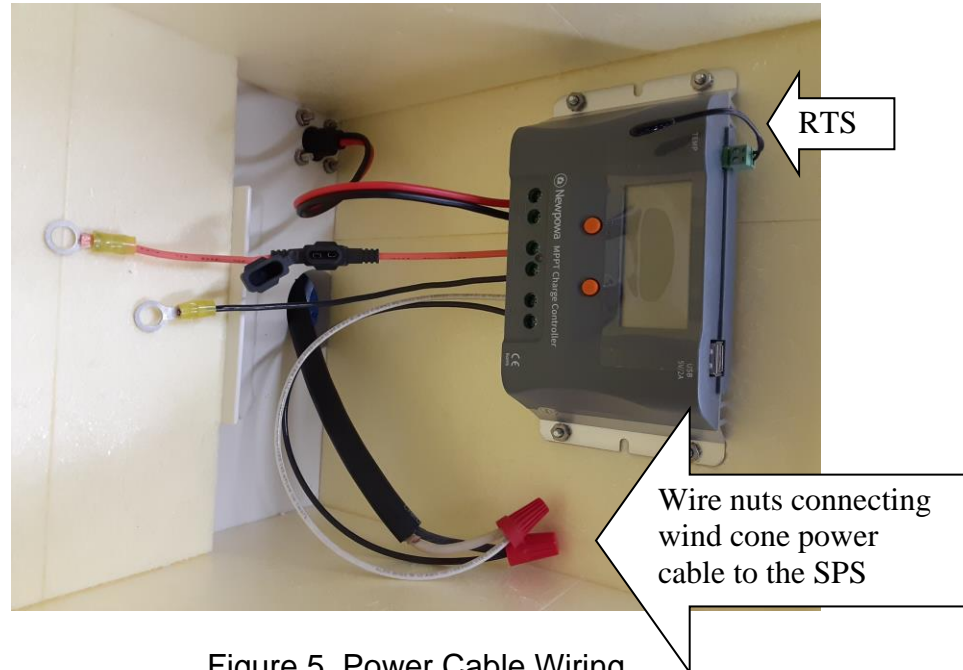

#### 4.3.5 Install the Batteries

Proceed as follows to install the batteries:

1. Locate the battery connection wires and fuses (packed with this manual).
2. **Caution-The fuses are not installed in the inline fuseholders. Do not install the fuses until instructed to do so.**
3. Unpack the batteries from their packing materials. Locate the battery terminal bolts and washers, shipped with each battery.
4. Place the batteries in the battery enclosure, with the battery connection posts towards the charge controller, as shown in Figure 6. The batteries are installed as close as possible to the charge controller, snugly against the battery stop in the floor of the battery enclosure.
5. The batteries are wired to the charge controller as described in the following steps. Use the bolts supplied with the batteries, and loosely hand-tighten the bolts as you make the connections. The battery bolts will be tightened with a wrench after all the connections are in place.



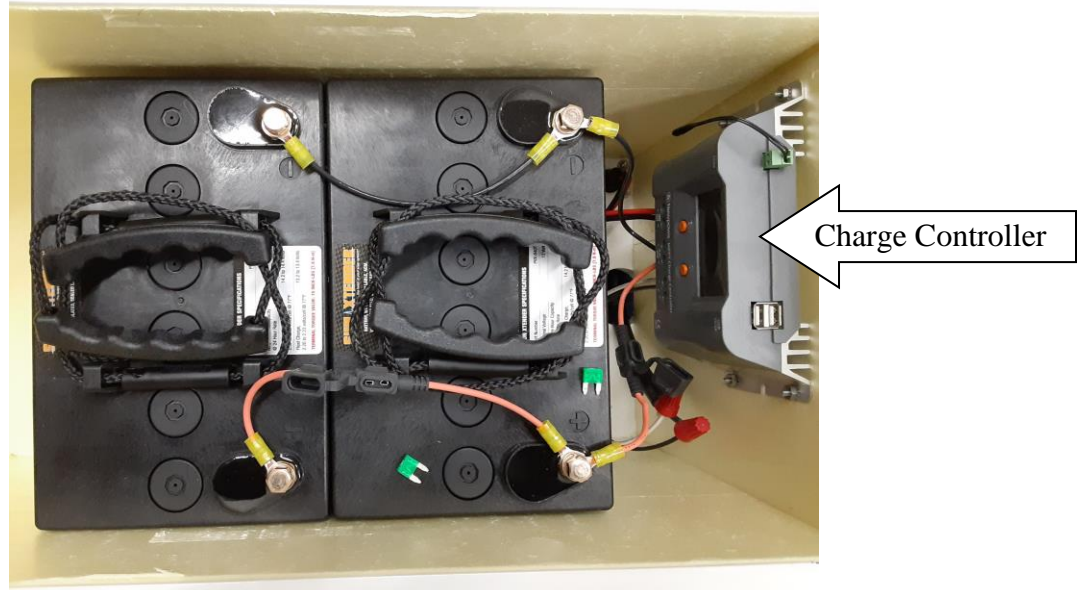

Figure 6. Battery Installation

6. Locate the orange wire with the inline fuseholder connected to the charge controller. Connect this wire to the positive terminal of the first (closest) battery.
7. Connect another orange wire with fuseholder from the positive terminal of the first battery to the positive terminal of the second battery.
8. If a third battery is supplied with the product, connect another orange wire with fuseholder from the positive terminal of the second battery to the positive terminal of the third battery.
9. Locate the black battery wire. One end is connected to the charge controller.
10. Connect this black wire to the negative terminal of the first battery.
11. Connect another black wire to the negative terminal of the first battery.
12. Connect the black wire from the first battery to the negative terminal of the second battery, as shown in Figure 6.
13. If a third battery is supplied with the product, connect another black wire from the negative terminal of the second battery to the negative terminal of the third battery.
14. Inspect all battery connections for proper wiring. Tighten each battery terminal bolt securely with a wrench.

#### 4.3.6 Install the Fuses

Proceed as follows to install the fuses:

1. This product has one 30 ampere fuse for each battery. Locate the fuses (shipped with this manual).

2. Figure 7 illustrates a typical inline fuseholder. Install a fuse in each fuseholder. Note: When the fuse is installed for the battery closest to the charge controller, the system will start to operate.

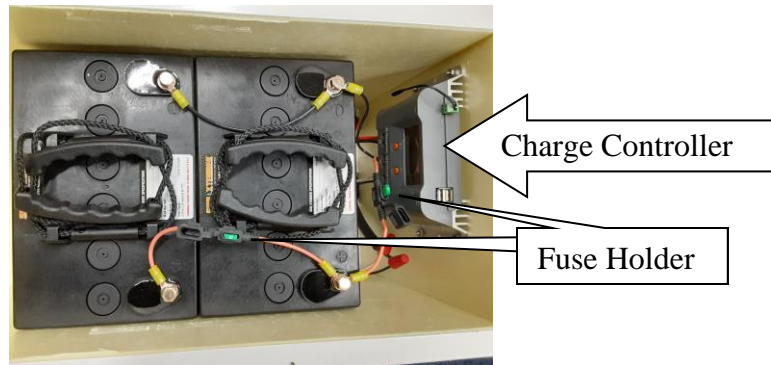

Figure 7. Fuse Installation

3. **Be sure to install 1 fuse for each battery. If fuses are not installed for every battery, the unit will operate, but will not have full battery capacity.**
4. Snap the fuseholder cover over each fuse.



### 4.3.7 Electrical Checkout

Inspect the SPS for proper electrical operation, as follows:

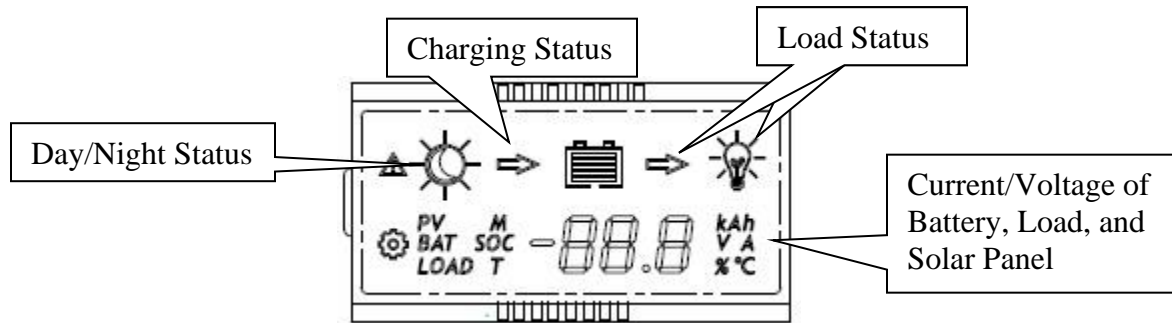

LCD interface panel on Charge controller (For more detailed information see owner's manual provided with product)

1. The SPS should now be operating. Locate the charge controller, as shown in Figure 7.
2. On the front surface of the charge controller, locate the LCD Interface.
3. The Interface will automatically cycle through 8 screens indicating battery, solar panel and load status.
4. Top row indicates day/night, charging status, and load status.
5. The day/night status will show a "moon". This indicates the charging system is in Night Mode, since the solar panel is still covered.
6. Inspect the wind cone light. The wind cone light should be "on" since the solar panel is covered.
7. Remove the protective cover from the solar panel. Assuming daylight is available, the day/night status will show a "sun". This indicates the charging system is in Day Mode. The wind cone light will be "off".
8. The charging arrow will be "on" indicating the solar panel is charging the batteries.
9. **Check to be sure 1 fuse is installed for each battery, and that each fuse is not blown. If good fuses are not installed for every battery, the unit will operate, but will not have full battery capacity.**
10. If the product performs as stated above, it is functioning correctly. If the wind cone light does not function correctly, contact Hali-Brite® for assistance.

### 4.3.8 Install Battery Enclosure Cover

Install the battery enclosure cover as follows:

1. Inspect the black weather seal around the top edge of the battery enclosure, to make sure it was not damaged during this installation process.

2. Locate the enclosure cover vent, as shown in Figure 8a. Orient the enclosure cover as shown, positioning the vent next to the enclosure wall opposite the photocell.

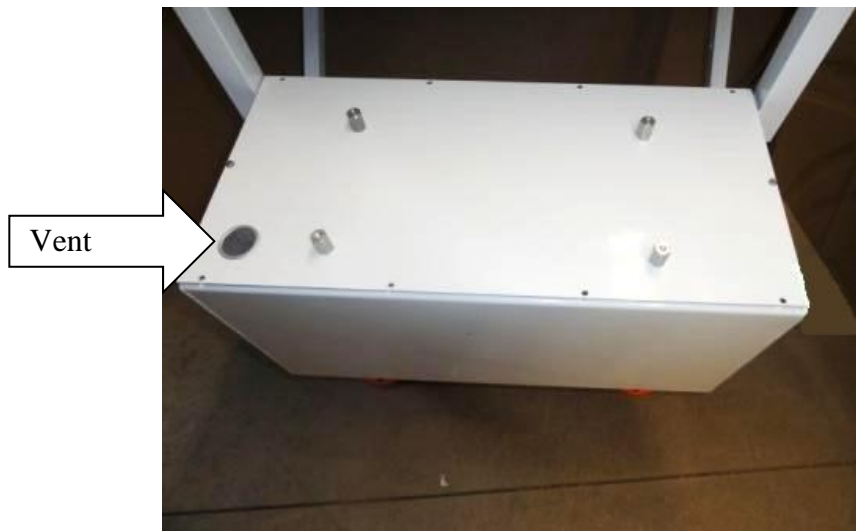

Figure 8a. Cover Installation

3. Place the cover on the enclosure, as shown in Figure 8a, aligning the mounting holes in the cover with the holes in the enclosure.
4. Install the 10 mounting screws in the cover, but do not tighten.
5. Tighten the screws evenly and equally around the cover, until the weather seal is compressed to about half of its original height.
6. Install the shade to the 4 mounting posts on the enclosure cover, as shown in Figure 8b, using the 4 bolts provided. Tighten each bolt securely.
7. Clean the glass on the face of the solar panel.
8. Installation of the SPS is now complete.



Figure 8b Shade Installation

# 5 Maintenance

## 5.1 Maintenance Schedule

<u>Interval</u>	<u>Task</u>
Daily	Inspect the wind cone for proper lamp operation.
As Needed	Clean the solar panel glass. Make sure vegetation is not obstructing the solar panel.
Annually	Remove the battery enclosure cover, and inspect all electrical connections.

# 6 Repair

**Note: Be sure you have correctly identified the faulty component prior to making any repairs. Troubleshooting SPS problems can be complex. Contact Hali-Brite® for troubleshooting assistance.**

## **6.1 Battery Replacement**

Batteries are replaced as follows:

1. Install a temporary cover on the solar panel, to prevent battery charging.
2. Remove the battery enclosure cover, by reversing the procedure described in Section 4.3.8.
3. Remove the battery fuses, by reversing the procedure described in Section 4.3.6.
4. Remove the batteries, by reversing the procedure described in Section 4.3.5.
5. Install the new batteries, using the procedure described in Section 4.3.5.
6. **Note: The new batteries must be the same model as the original, to ensure adequate performance. All batteries must be replaced at the same time.**
7. Install the fuses, using the procedure described in Section 4.3.6.
8. Remove the temporary cover from the solar panel.
9. Perform the electrical checkout as described in Section 4.3.7.
10. Install the battery enclosure cover, using the procedure described in Section 4.3.8.

## **6.2 Fuse Replacement**

The fuses are replaced as follows:

1. Install a temporary cover on the solar panel, to prevent battery charging.
2. Remove the battery enclosure cover, by reversing the procedure described in Section 4.3.8.
3. Remove the battery fuses, by reversing the procedure described in Section 4.3.6.
4. Acquire the proper replacement fuses.
5. Install the fuses, using the procedure described in Section 4.3.6.
6. Remove the temporary cover from the solar panel.
7. Perform the electrical checkout as described in Section 4.3.7.
8. Install the battery enclosure cover, using the procedure described in Section 4.3.8.

### 6.3 Solar Panel Replacement

To replace the solar panel:

1. Install a temporary cover on the solar panel, to prevent battery charging.
2. Remove the battery enclosure cover, by reversing the procedure described in Section 4.3.8.
3. Remove the battery fuses, by reversing the procedure described in Section 4.3.6.
4. The solar panel is attached to its mount with 4 bolts. Refer to Figures 9 and 10 to locate the bolts, and remove them. Carefully lower the solar panel on to a supporting surface.



Figure 9. Lower Solar Panel Mounting Bolts



Figure 10. Upper Solar Panel Mounting Bolts



Figure 11. Solar Panel Connectors

5. Locate the wires coming from the solar panel on the rear surface of the solar panel. Disconnect the solar panel connectors as shown in Figure 11.
6. Remove the defective solar panel, and position the replacement solar panel for reassembly.
7. Attach the solar panel to the mounting brackets with the 4 mounting bolts, and tighten securely.
8. Reconnect the solar power connectors as shown in Figure 11.
9. Install the fuses, using the procedure described in Section 4.3.6.
10. Perform the electrical checkout as described in Section 4.3.7.
11. Reinstall the battery enclosure cover by following the procedure described in Section 4.3.8.

## 6.4 Charge Controller Replacement

Perform the following steps to replace the charge controller:

1. **Note: The charge controller is custom-programmed by Hali-Brite® . Do not install a controller purchased elsewhere, it will not operate properly. Acquire a new charge controller before continuing this procedure.**
2. Install a temporary cover on the solar panel, to prevent battery charging.
3. Remove the battery enclosure cover, by reversing the procedure described in Section 4.3.8.
4. Remove the battery fuses, by reversing the procedure described in Section 4.3.6.

5. Locate the charge controller, as shown in Figure 12.

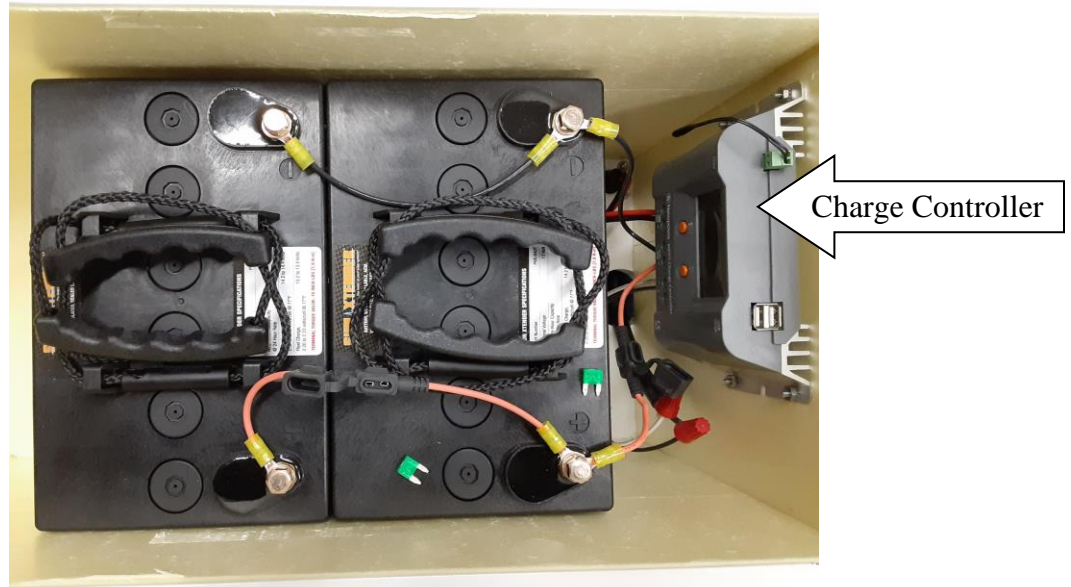

Figure 12. Charge Controller

6. Position the new charge controller near the old one. Remove the wires from the terminal block on the old charge controller, one at a time, and secure them to the same terminal on the new charge controller.
7. Remove the 4 mounting bolts from the old charge controller, and remove it from the battery enclosure.
8. Attach the new charge controller to the battery enclosure with the 4 mounting bolts, and tighten securely.
9. Install the fuses, using the procedure described in Section 4.3.6.
10. Remove the temporary cover from the solar panel.
11. Perform the electrical checkout as described in Section 4.3.7.
12. Reinstall the battery enclosure cover.

## 6.5 Frangible Coupling Replacement

To replace the frangible couplings, perform the following steps:

1. **Note: Always replace both frangible couplings at the same time. The frangible couplings are unique for this product, and must be obtained from Hali-Brite®.**
2. Remove the battery enclosure cover, by reversing the procedure described in Section 4.3.8.
3. Remove the battery fuses, by reversing the procedure described in Section 4.3.6.
4. Disconnect the wind cone power cable, by reversing the procedure described in Section 4.3.4.
5. Refer to Figure 13 to locate the frangible couplings and flanges.



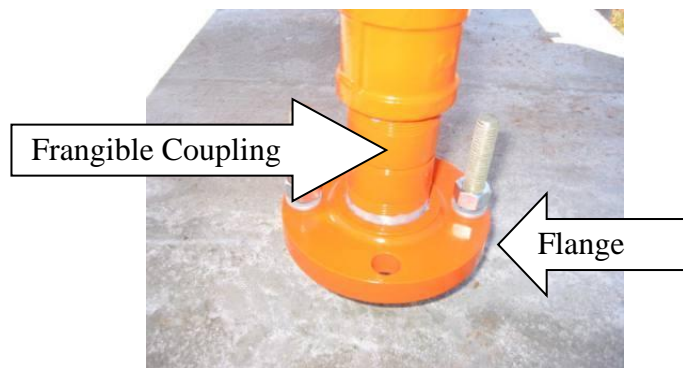

Figure 13. Frangible Coupling

6. **Caution: The following steps should be performed by 2 people.**
7. One person should support the SPS while the other person removes the 4 bolts attaching the SPS to the mounting base.
8. Lift the SPS off of the mounting base bolts, and support the SPS on the mounting base, next to the bolts.
9. Pull the wind cone power cable out of the SPS mounting leg.
10. Using a pipe wrench, remove the frangible coupling from each of the 2 SPS legs.
11. Using pipe wrenches, separate the 2 flanges from each of the frangible couplings. Discard the old frangible couplings.
12. Thread a new frangible coupling on to each of the 2 mounting legs.
13. Thread a flange on to each of the 2 frangible couplings.
14. Tighten each flange and frangible coupling to each mounting leg. After tightening, make sure the holes in each flange align with the bolts on the mounting base.
15. Reinstall the wind cone power cable through the mounting leg, and into the battery enclosure.
16. Lift the SPS on to the mounting base, while guiding the mounting legs on to the 4 mounting bolts. Install a lock washer and nut on to each of the 4 mounting bolts.
17. The bottom nuts on the mounting bolts are used to level the SPS. Place a level on the top surface of the battery compartment, and adjust the 4 bottom nuts until the battery compartment is level in all directions.
18. Tighten the top nut on each of the 4 mounting bolts to secure the SPS to the mounting base.
19. Reconnect the wind cone power cable, using the procedure described in Section 4.3.4.
20. Install the fuses, using the procedure described in Section 4.3.6.
21. Reinstall the battery enclosure cover.



## 6.6 Solar Panel Angle Adjustment

The angle of the solar panel is factory set for the installation location. No further adjustment is necessary. However, if adjustment is required, proceed as follows:

1. Refer to Figure 14. A series of holes located in each of the two solar panel side brackets are used to select the solar panel angle. The 5 holes in each side bracket allow the elevation angle to be set to 25, 35, 45, 55 or 65 degrees above horizontal.
2. Determine the geographic latitude of the installation location.
3. The desired solar panel elevation angle is the latitude plus 15 degrees.

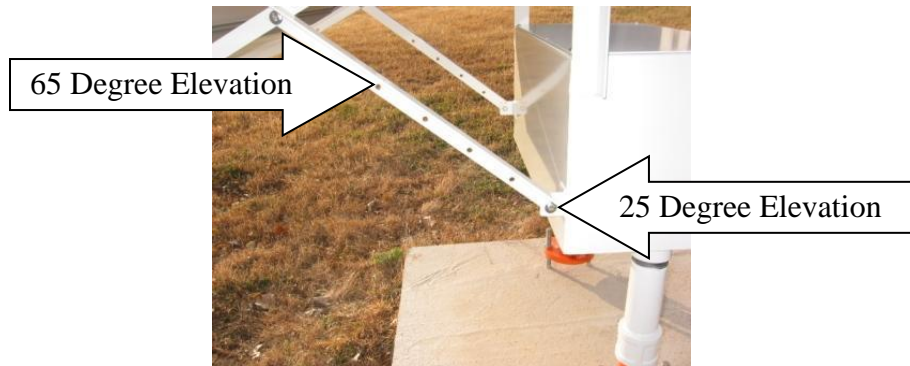

Figure 14. Solar Panel Angle Adjustment

4. Choose the mounting holes which will result in an elevation angle closest to the desired elevation angle.
5. If it is necessary to change the angle, remove the bolt from each side bracket, reposition the solar panel, reinstall the bolts, and tighten securely.

# 7 Replacement Parts

<b>Part Number</b>	<b>Description</b>
2300-0024	Fuse, MINI 30 amp 32 volt
1300-0081	Battery
1800-0036	Frangible Coupling
4500-0022	Charge Controller
1067-0002	Mounting Flange
7300-0022	Weatherstrip, Battery Enclosure
1049-0015	Anchor Assembly
7800-0010	Solar Panel, 100 Watt
7800-0011	Solar Panel, 200 Watt

## Revision Table:

<b>Rev #</b>	<b>Date</b>	<b>Changes</b>
<b>6</b>	<b>5.29.2020</b>	<b>Updated photos and new Address for Hali-Brite, Inc.</b>
<b>7</b>	<b>2.16.22</b>	<b>Updated Model numbers from SPS-50, SPS-135 to SPS-100, SPS-200 to reflect new 100 and 200watt solar panels. Updated solar panel info and drawings to reflect new panels. Updated charge controller information to reflect new charge controller</b>